



**Colour TV
Service Manual**

Model Group: CT-21FGS1

**CHASSIS:
A21T01(TB1238)**

**MODEL:
CT-21FGS1**

CONTENT

GERAL DESCRIPTION.....	4
SAFETY INSTRUCTION	6
CIRCUIT ADJUSTMENT	7
FAULT FINDING TREES, DIAGRAMS & OVERVIEWS	14
VARIOUS PARAMETERS OF INTEGRATED CIRCUIT	22
ELECTRICAL PART LIST	30
CIRCUIT DIAGRAM	40

GENERAL DESCRIPTION

AKIRA AKTP01 is a CTV monolithic chassis currently developed by AKIRA Co. It introduces a monolithic IC TB1238AN developed by Toshiba Co. To carry out all the small signal processing TB1238AN is a kind of IC used by color TV in PAL/NTSC system, which is controlled by Inter IC Bus. Together with the SECAM decoder TA1275Z, it can form a signal processing circuit for multi-system color TV. This chassis is used in many fashionable TV receiver technologies, which makes the performance reach the advanced level of the world.

Figure 1 shows the block diagram of AKTP01(A21T01).

Table 1 provides A21T01 mainly ICs and functions.

Figure 2 shows the whole set power supply system for AKTP01(A21T01).

Figure 3 shows the system control circuit of AKTP01(A21T01).

Table 1: A21T01 mainly ICs and functions

Location	Type	Function Description
D901	87CM38N-3GN5/ 87CK38N-2B46	System control microprocessor
D902	AT24C08	EEPROM
N101	LA7910	Band decoder
N252	CD4053BE	TV/AV switching
N203	CD4053BE	AV1/AV2 Switch
N201	TB1238AN	Small signal processor (IF/VIDEO/CHROMA/DEF)
N402	LA7830	Vertical output power amplifier
N701	TA1275AZ	SECAM decoder
N202	CD4052BE	Sound system switching
N701	AN5270	Audio power amplifier (L)
N711	AN5270	Audio power amplifier(R)
A903	HS0038A	Remote control receiver

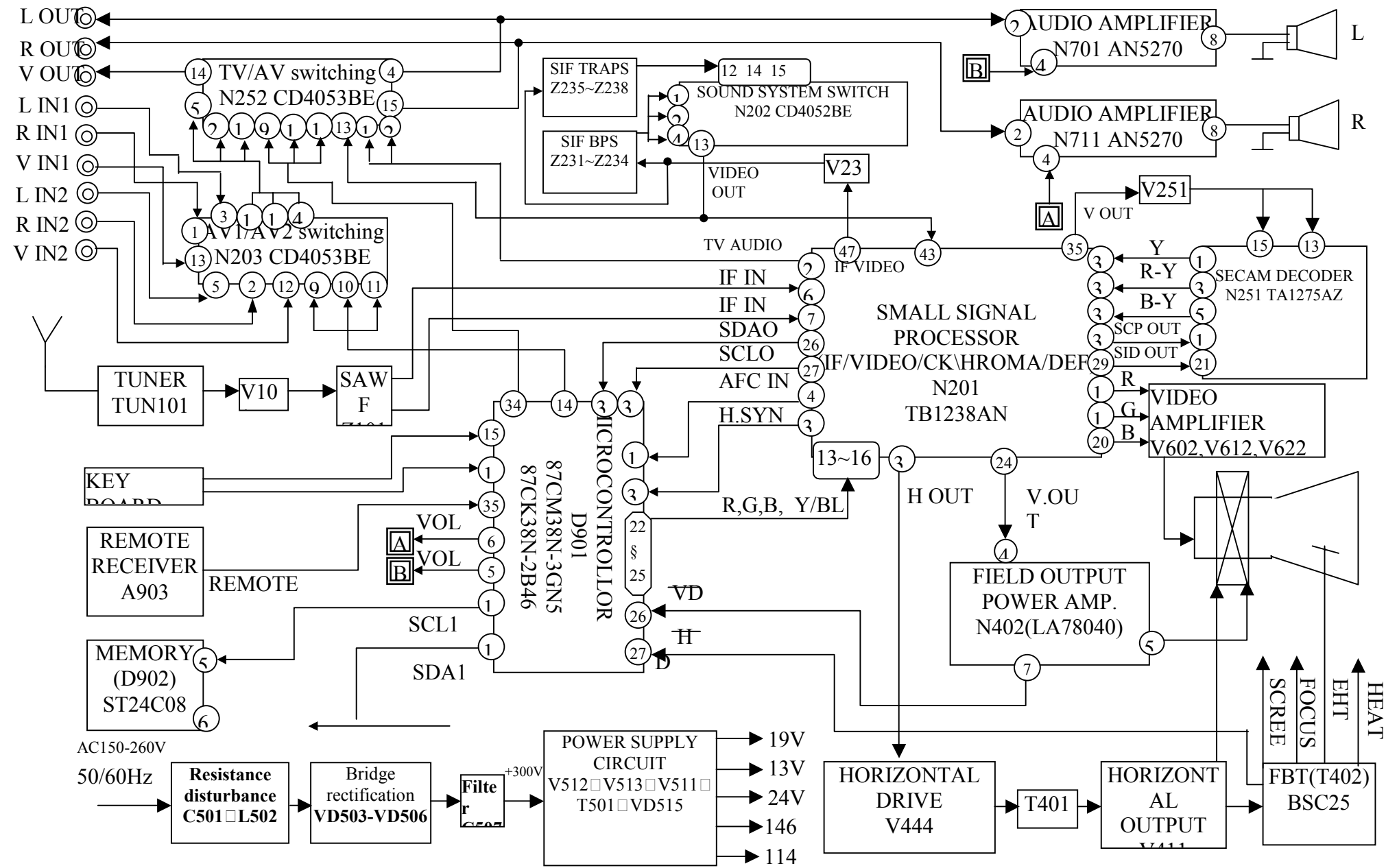

SAFETY INSTRUCTION

Warning: Before examining and servicing this chassis, read carefully the following safety instruction.

X-RAY RADIATION PRECAUTION

1. The EHT must be checked every time the receiver is serviced to ensure that the CRT does not emit X-ray radiation as result of excessive EHT voltage. The nominal EHT for this receiver is 22KV at zero beam current (minimum brightness) operating at AC 220V. The maximum EHT voltage permissible in any operating circumstances must not exceed 25KV. When checking the EHT, use the High Voltage Check procedure in this manual using an accurate EHT voltmeter.
2. The only source of X-RAY radiation in this receiver is the CRT. To prevent X-ray radiation, you should use the same type of CRT when replacing it.
3. Some components used in this receiver have safety-related characteristics preventing the CRT from emitting X-ray radiation. For continued safety, replacement component should only be made after referring the Product Safety notice below.

SAFETY PRECAUTION

1. The high voltage in the TV reaches to 22KV when the TV is in operation. Be more careful during opening the back cover.
 - a. The high voltage existing in the TV is very dangerous. Refer servicing to qualified personnel only.
 - b. Before removing the high voltage cap. Discharge the anode of the CRT and the chassis in case of electric shock.
 - c. Wear a pair of goggles when handling the CRT to avoid broken pieces damaging your eyes.
 - d. Do not hold the CRT neck in case of causing damage to the CRT.
2. When the power cord needs replacing, use the same one as that provided by AKIRA factory.
3. Voltage exists between the hot and cold ground when TV is in operation. Install a separation transformer during repairing or connecting to any tester for the sake of safety. The power of the separation transformer should be beyond rated overall power.
4. When replacing a burnout fuse, use the one with the same specifications as the original.
5. When replacing old wire, wind new one round the shaft to weld. When replacing components with safety in performance, use the same type as that specified by AKIRA and install it in the former way.
6. Never place wire near high-temperature or high-voltage components.

SAFETY CAUTIONS FOR PRODUCTS

Many electric and mechanical components in AKPH01 /02 chassis have special safety performances, which are always neglected. Even if replacing them with some components with the same voltage and power, you can not get effective protection to X-ray. In the circuit diagram, these special electric components are indicated by the special mark $\Delta!$ and on the shadow. When replacing any of them, use the one with the same specifications as the original's. Otherwise, it may cause X-ray radiation and damage to overall safety.

CIRCUIT ADJUSTMENTS

GENERAL INFORMATIONS

All adjustment are thoroughly checked and corrected when the receiver leaves the factory. Therefore the receiver should operate normally and produce proper color and B/W pictures upon installation. However, several minor adjustments may be required depending on the particular location in which the receiver is operated.

This receiver is shipped completely in carton. Carefully draw out the receiver from the carton and remove all packing materials. Power cord into a convenient 220 volts 50 Hz AC two pin power outlet. Turn the receiver ON. Check and adjust all the customer controls such as BRIGHTNESS, CONTRAST and COLOUR Controls to obtain natural color or B/W picture.

AUTOMATIC DEGAUSSING

A degaussing coil is mounted around the picture tube so that external degaussing after moving the receiver is normally unnecessary, providing the receiver is properly degaussed upon installation. The degaussing coil operates for about 1 second after the power to the receiver is switched ON. If the set is moved or faced in a different direction, the power switch must be switched off at least 30 minutes in order that the automatic degaussing circuit operates properly. Should the chassis or parts of the cabinet become magnetized to cause poor color purity, use an external-degaussing coil. Slowly move the degaussing coil around the faceplate of the picture tube, the side and front of the receiver and slowly withdraw the coil to a distance of about 2m before disconnecting it from AC source. If color shading still persists, perform the COLOUR PURITY ADJUSTMENT and CONVERGENCE ADJUSTMENTS procedures.

ADJUSTMENT MODE

Item	B+ adjustment, TV signal receiving
	AKPH01 chassis
Measuring Equipment	No. 5 Service Remote Controller
Preparation Before Adj.	The set is turned on and work normally. No signal input

Adjustment procedure

1. Press S-PVOC key to set PIF-VOC self-adjusting.
2. OSD appears as below, after adjustment finished.



Self-adjusting



Adjusting OK

Note:

When the OSD appears 'AFT NG', it means that AFT adjusting is not good. Please check the chassis if there is circuit short or parts wrong fitting. If not, counter-clockwise or clockwise turn a ferrite core in T211 at 1/4 to 1/2 turn.

Item	B+ adjustment, TV signal receiving
	AKTP01 chassis
Measuring Equipment	TV SG (Signal Generator) Digital multi-meter
Preparation Before Adj.	The set is turned on Connect the TV SG to RF input terminal of the set.

Adjustment procedure

1. Turn RP551 potentiometer to adjust B+ to specified voltage.
2. Check voltages for video out, vertical out, circuit work and audio power out as follow.

	Voltage (volt)		Tolerance
	14 inch	21 inch	
Video Out	145	188	±5V
Vertical Out	26	26	±1V
Circuit Work	13	13	±1V
Audio Power Out	19 for 3W 22 for 5W	19 for 3W 22 for 5W	±1V

3. TV signal receiving
 - a. Press MENU key, to select POS.MEMORY item.
 - b. Press V+ or V- key, to select SEARCH or AUTOMEMORY item, press P+ key to start searching.
 - c. Press P+ or P- key to inspect the set if there is channel skipped, if so, searching again by SEARCH as above described.



Item	TV system adapting & AV in/output inspection
	AKTP01 chassis
Measuring Equipment	SG (with NTSC3.58). User remote controller Dual trace oscilloscope
Preparation before Adj.	Input TV and AV signal

Inspection procedure

1. Input the TV signal which system is designated in technical specification.
2. Switch TV system to the set by pressing SYS key on user remote controller according to the TV system in SG. The picture and sound must be normal.
3. Press TV/AV key, to select VIDEO1 or VIDEO2 input. The picture and sound must be normal
4. AV output inspection. Load a 75 Ω resistor to VIDEO output terminal, 1Vp-p video output signal that is from TV signal or from VIDEO1 or VIDEO2 input signal should be observed on the oscilloscope. Load two 10K resistors separately to AUDIO R and L output terminals, two 0.7Vp-p audio output signal that is from TV or from AV input signal (stereo) should be observed on the oscilloscope.

Item	General adjustment
	AKTP01 chassis
Measuring Equipment	SG No.1 and No.2 service remote controller and user remote controller
Preparation before Adj.	Brightness, contrast and color should be set in standard Press PP key repeatedly to set the picture at MEMORY2 (in standard)

Adjustment procedure

1. Receive the monoscope pattern signal
2. Turn the focus adjusting VR to make the picture clear.
3. Press M-ON key on No.2 service remote controller to set the set into manufactory adjustment mode.
4. Adjust the picture size roughly by No.2 service remote controller.
5. Grid 2 voltage adjustment. Press  key on No.1 service remote controller, to set the screen into a horizontal line. Clockwise turn the screen VR gradually until a horizontal line appears on the screen.
6. Press R+ or R- (with the red block), G+ or G- (with the green block) and B+ or B- (with the blue block) key respectively, to adjust a horizontal line appeared to the white colour.
7. Press  key again and changing back to normal screen.

Item	Focus adjustment
	AKTP01 chassis
Measuring Equipment	SG
Preparation before Adj.	Brightness, contrast and color should be set in standard

Adjustment procedure

1. Receive the cross-hatch pattern signal
2. Turn the focus adjusting VR watching the screen and adjust the vertical line of  mark to make the most thin. Then the focus adj. VR is set as close low voltage side as possible.
Stop the focus adj. VR at the point that focus is a bit worse at once, turn back to the left and then turn back to the right a little again.

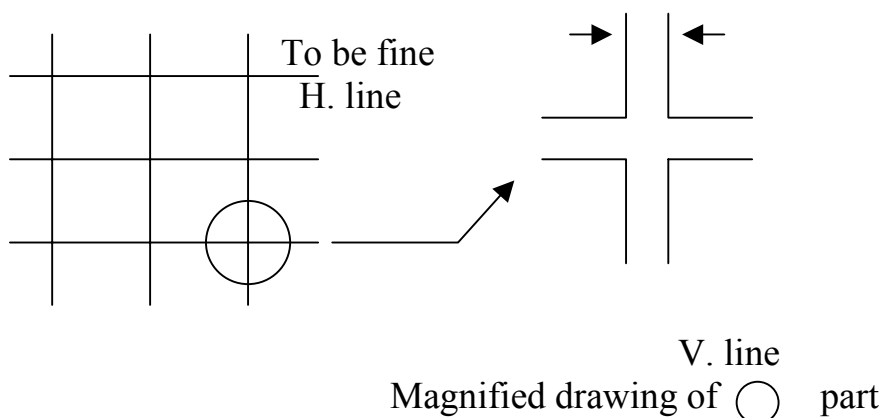

Item	White balance adjustment
	AKTP01 chassis
Measuring Equipment	SG and white balance meter No.1 service remote controller
Preparation before Adj.	Warm up the set for more than 30 min. Brightness, contrast and color should be set in standard

Adjustment procedure

1. Receive the monoscope pattern signal.
2. Press G (G.DRIVE) key and B (B.DRIVE) key on No.1 service remote controller to select G-DRV and B-DRV respectively, then press + or – key to adjust the white balance at the directed value (which is according to the specification of factory's adjustment)
3. Press R+ or R-, G+ or G- and B+ or B- key respectively to adjust the white balance of low light until the white balance of high and low light is good

Item	RF. AGC adjustment
	AKTP01 chassis
Measuring Equipment	SG and digital multi meter No.5 service remote controller
Preparation before Adj.	Connect a digital multi meter to TP101 point on the chassis

Adjustment procedure

1. Receive the color bar signal that is 87.5% modulation and 60dBu level
2. Press RF AGC key on No.5 service remote controller to select RF. AGC adjustment, press + or – key to adjust the voltage of RF AGC to $3.7 \pm 0.1V$ that is read on the digital multi meter.





Item	Vertical height, linearity and Hor. position adjustment
	AKTP01 chassis
Measuring Equipment	SG No.2 and No.3 service remote controllers
Preparation before Adj.	Brightness, contrast and color should be set in standard

Adjustment procedure

1. Receive the 5-circles pattern signal that is 50HZ vertical frequency.
2. Press V-LINE, V-SIZE, V-CENT and H-CENT key on NO.2 service remote controller respectively to select the vertical linearity, height, center (position) and horizontal center (position) adjustment, and then press + or - key to adjust the value of them respectively according to factory's specification.
3. Receive the 5-circles pattern signal that is 60HZ vertical frequency
4. Press V-LINE, V-SIZE, V-CENT and H-CENT key on NO.3 service remote controller separately to adjust the vertical linearity, height, center and horizontal center as above item 3.

Item	OSD position adjustment
	AKTP01 chassis
Measuring Equipment	No.1 and No.5 service remote controller
Preparation before Adj.	Brightness, contrast and color should be set in standard

Adjustment procedure

1. Press D-MODE key on No.1 service remote controller to set the set into design mode adjustment.
2. Press  or  key to select OSD item, press  or  key to adjust the OSD to the center position on the screen or press RF AGC key on No.5 service remote controller and press + or – key to adjust the OSD position
3. Press D-MODE key again to quit design mode adjustment.

Item	The functions of the set inspection
	AKTP01 chassis
Measuring Equipment	SG User remote controller and No.
Preparation Before Adj.	The set is turned on

Inspection procedure

1. Receive the Philips pattern signal
2. Press PIC key on user remote controller to call the menu as adjusting picture quality. Adjust color, brightness, contrast, sharpness and tint (in NTSC) respectively and all adjustment should be right
3. Press V+ key to increase the sound volume, no distortion heard at maximum level, press V- key to decrease the sound volume, no sound heard at minimum level
4. Press POWER key to switch the set into standby status, at mean time the manufactory adjustment mode is cancelled.
5. Press POWER key again, the set should work in normal receiving mode.
6. Press  (mute), DISP (display), PP and SLEEP key respectively, the relevant function should be normal
7. Press S-OUT key on No.5 service remote controller to set default value that stored in E²PROM on the chassis for product shipment.

FAULT FINDING TREES, DIAGRAMS AND OVERVIEWS

1. Three-None (no raster, no picture, no sound)
This failure is mainly caused by big-power circuit such as power supply, horizontal scanning, vertical scanning.
The detail checking and repairing steps are as follow.

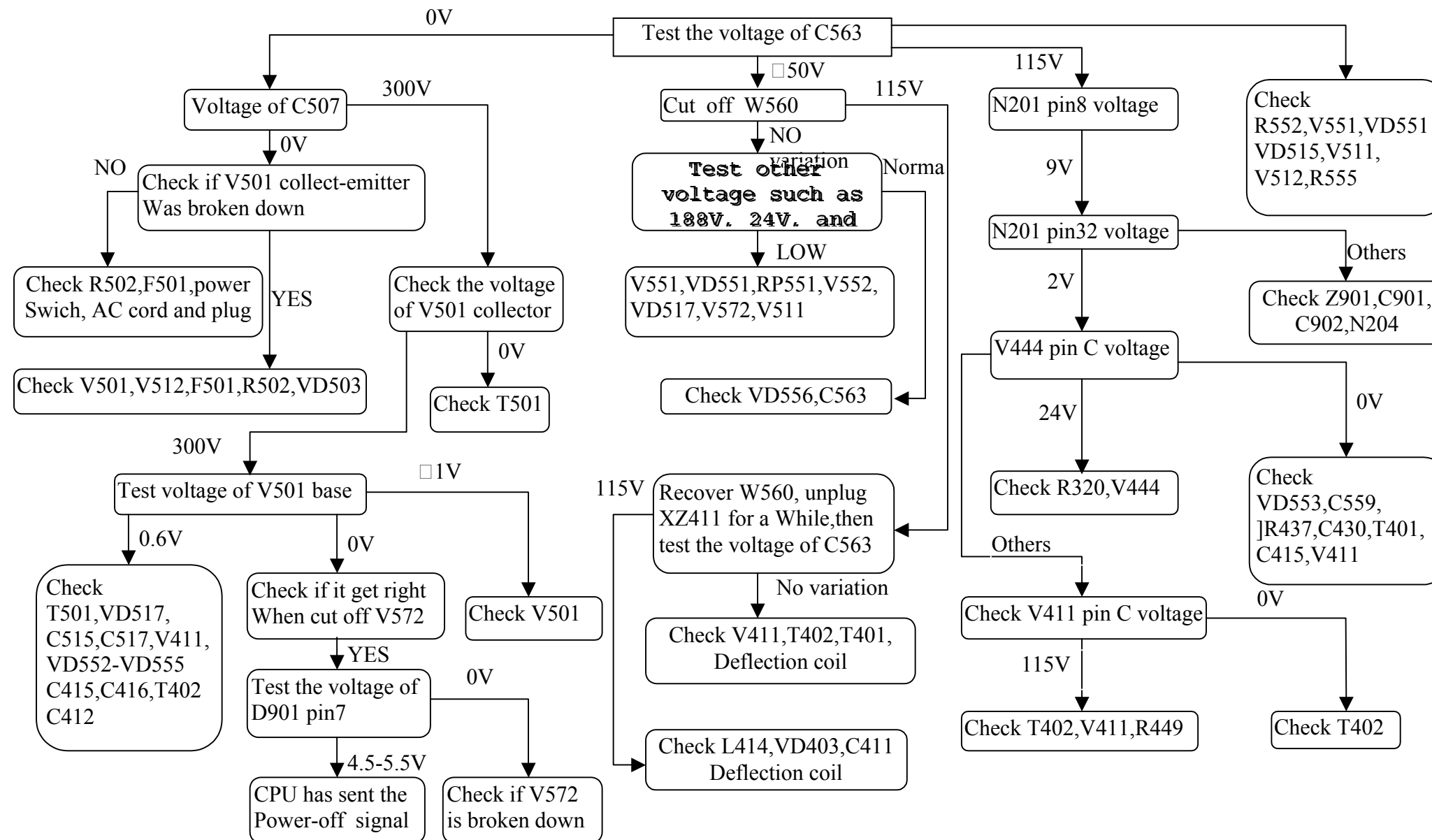

2. Two-None (no picture, no sound)

The failure shows that the set does not display the picture but it has noise wave or blue background or OSD on the screen. This means that the circuits of power supply, horizontal scanning, vertical scanning and video amplification are normal and they are not considered in the repairing. The failures are mainly in the small signal processing circuits.

Before checking these circuits, a kind of practical test method is introduced. It is called "Signal-input way". The detail is described as follow: We can use the resistance function of an analog multimeter, connect the red pole (negative in ohm scope) on the circuit board ground, then touch softly the test point with another pole (black pole) in ohm scope meanwhile observe the reactivity on the output device.

Note: In the TV test, we mainly observe the noise wave on the CRT and listen to the noise voice liking as "Ka.....Ka" from the loudspeakers.

a. No picture

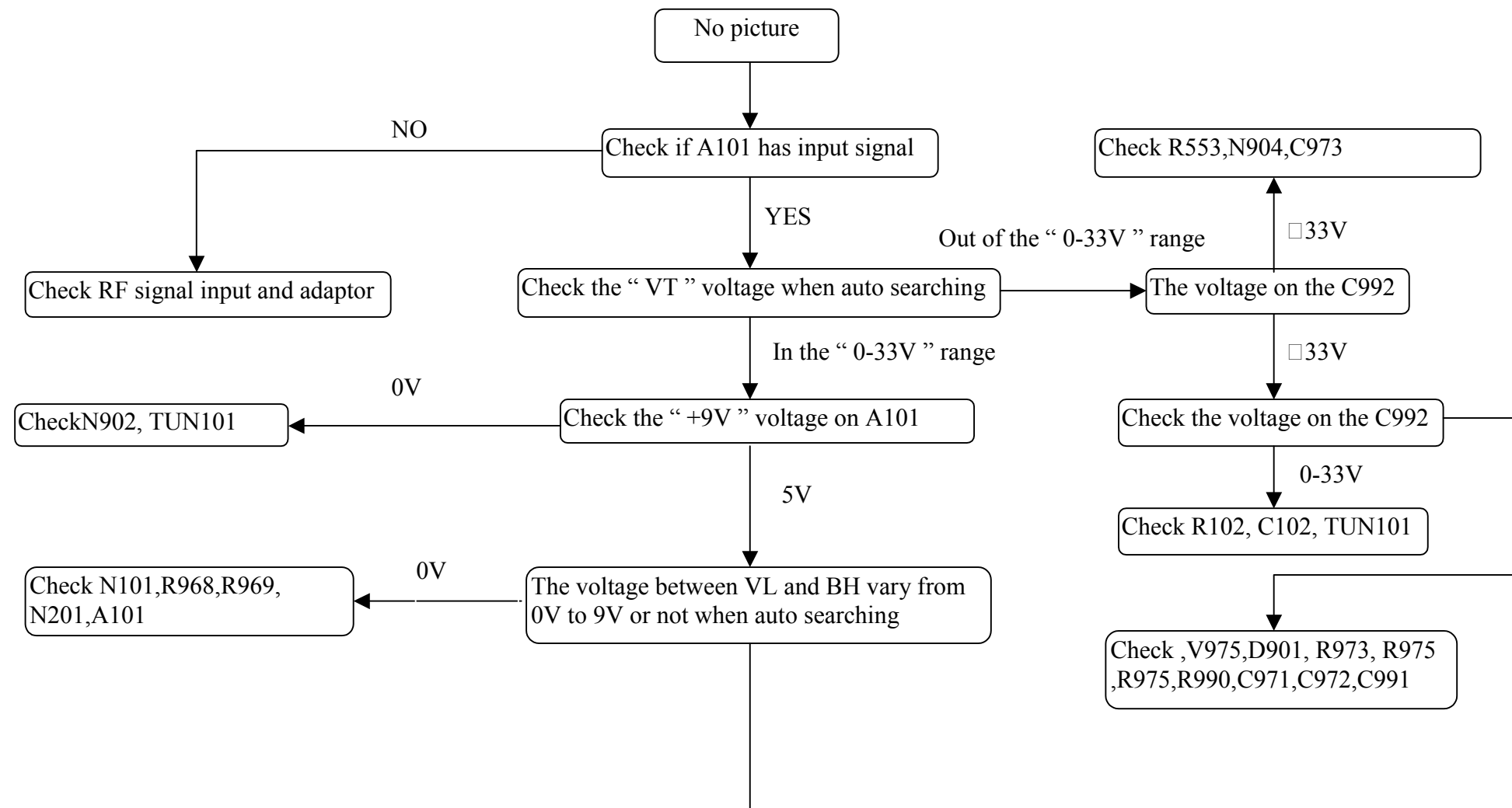

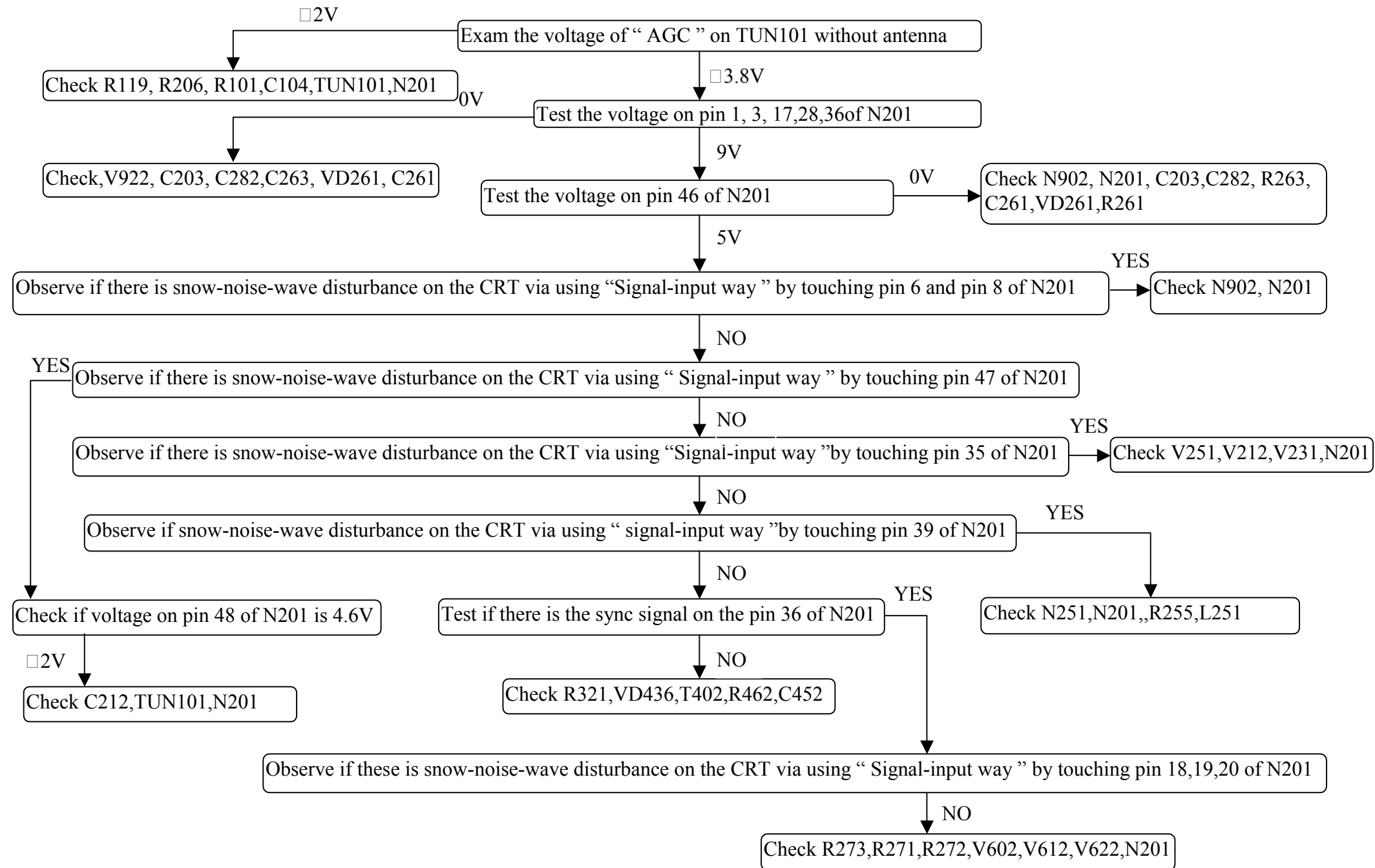

b. No sound

In this kind of failure, first of all we should observe if there is the picture on the CRT. It proves the small signal circuit to work correctly with the picture on the CRT and we only check the sound signal processing and sound amplification circuit. The repairing method (B1) may be referred without picture. The detail checking and repairing steps are as follow.

Note: Before repairing, assure that the volume is on and the state of set is in "TV".

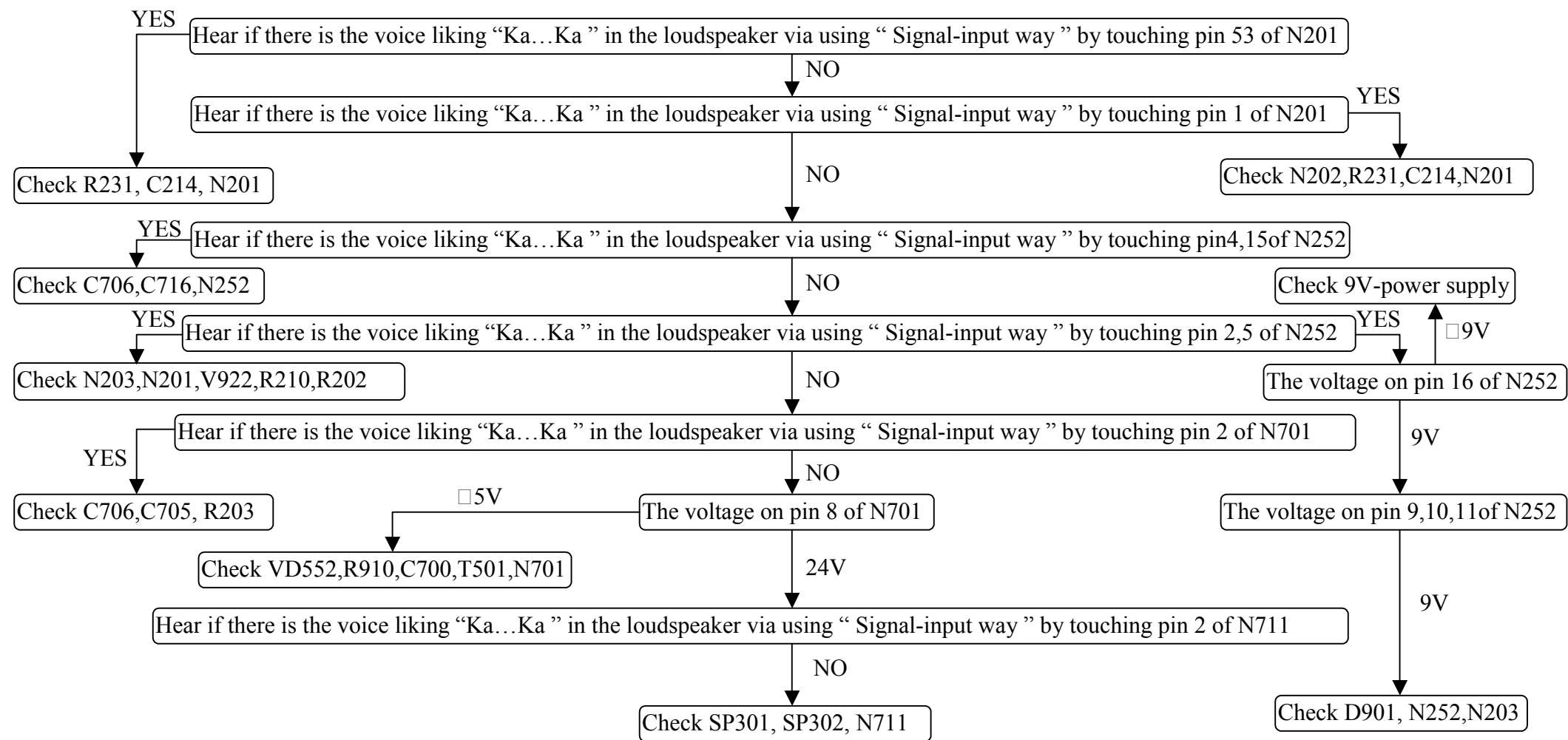

3. Only horizontal line in the middle of the screen:
 If vertical deflection circuit does not work, this kind of failure will happen. In deflection yoke, there only has horizontal sweeping, the electron beam in the CRT only moves in the horizontal orientation, so form this failure.
 (While checking horizontal and vertical deflection circuit' s failure, we have better to use an oscilloscope.)

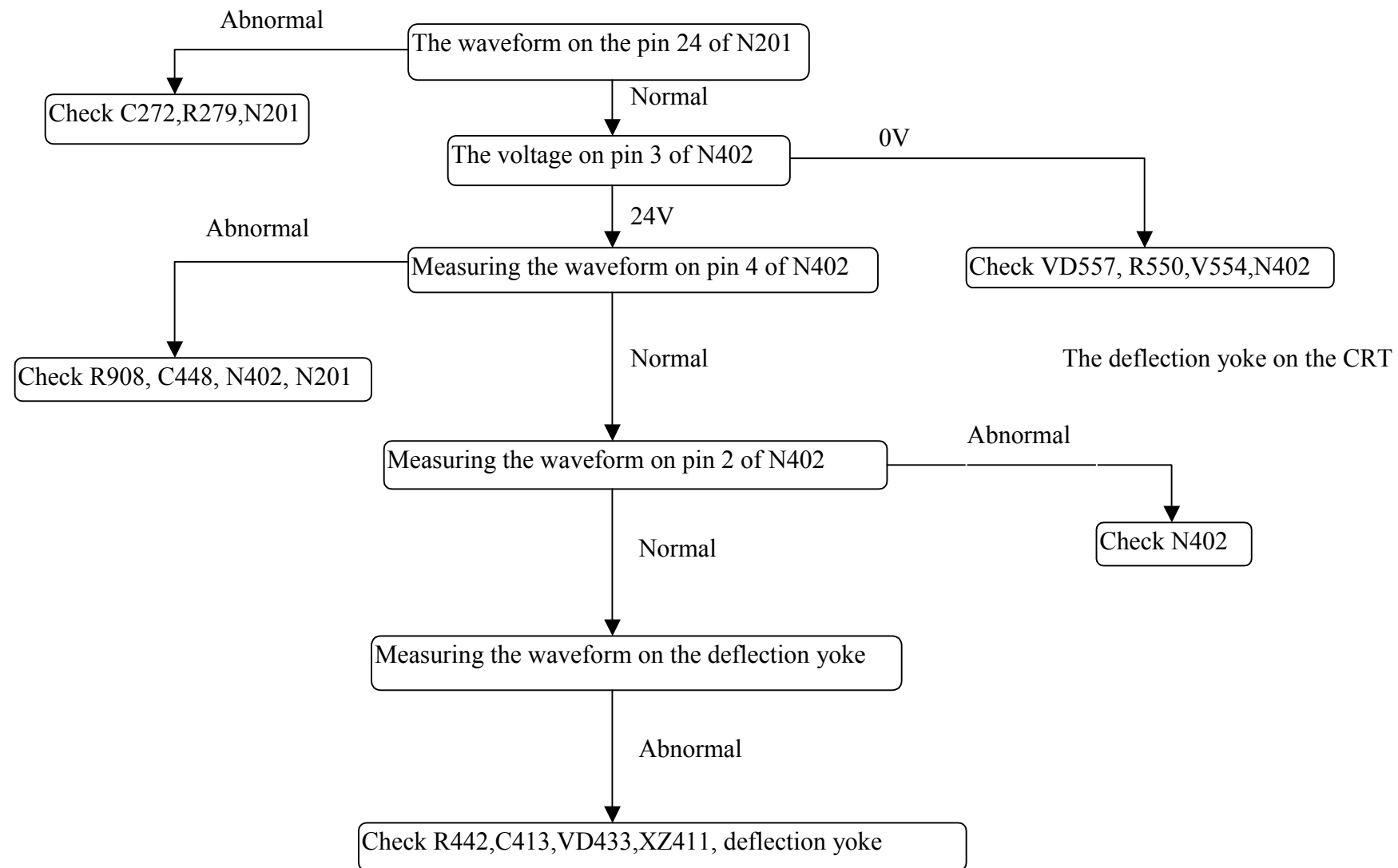

4. Only vertical line in the middle of the screen

This is a dangerous failure. It probable causes flashover and smoking inside the set. Don' t let your TV work for a long time as this failure appears. Because the electron beam can not move in the horizontal orientation, the failure should be in the horizontal deflection circuit. We mainly check the open-circuit fault in horizontal deflection circuit. The detail checking and repairing steps are as follow:

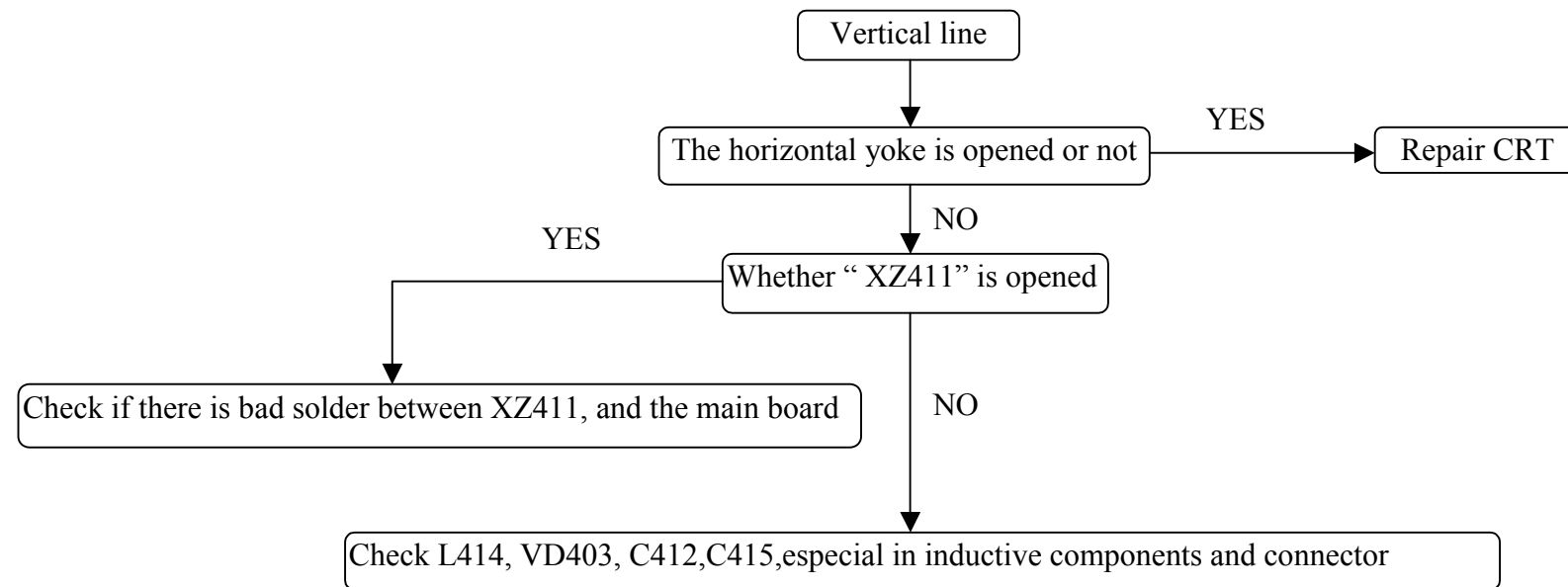

5. UOC does not work

In television, remote-control system is similar with the computer system. In theory , it can work if it holds two conditions as follow:

The power supply: In general, it is 5V, the error is not above 10% and the disturbance pulse is as small as possible.

The clock pulse: In TDA93XX circuit, the clock pulse is generated by pin58 / pin59 of N301 and 12M crystal oscillator.

Television' s remote-control system also needs reset circuit that can preset the values in internal register. The circuit around pin57 of N204 is called auto-reset circuit. If UOC detects errors in resetting, it will come to the state of programme protected.

The detail checking and repairing steps are as follow:

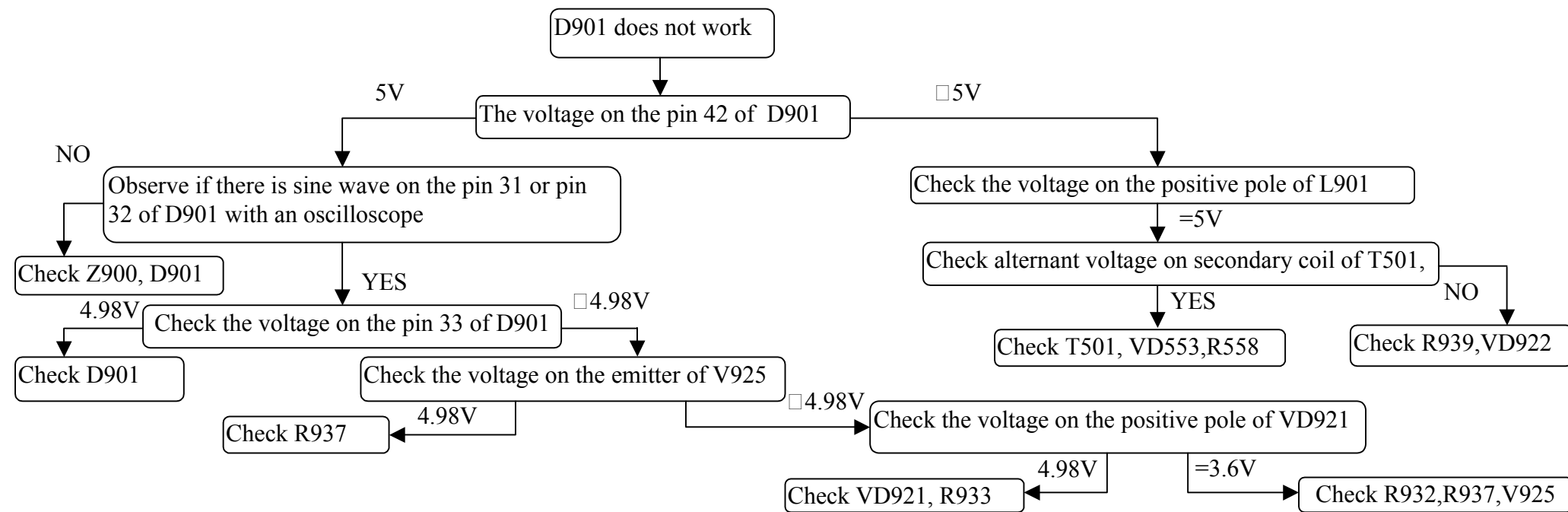

6. No OSD (On Screen Display)

This failure is usually caused by the circuit of character generated and located. Most of reasons are that the horizontal and vertical flyback pulse signals do not come to UOC.

We can judge this failure by measuring the wave of the character in an oscilloscope.

The detail checking and repairing steps are as follow:

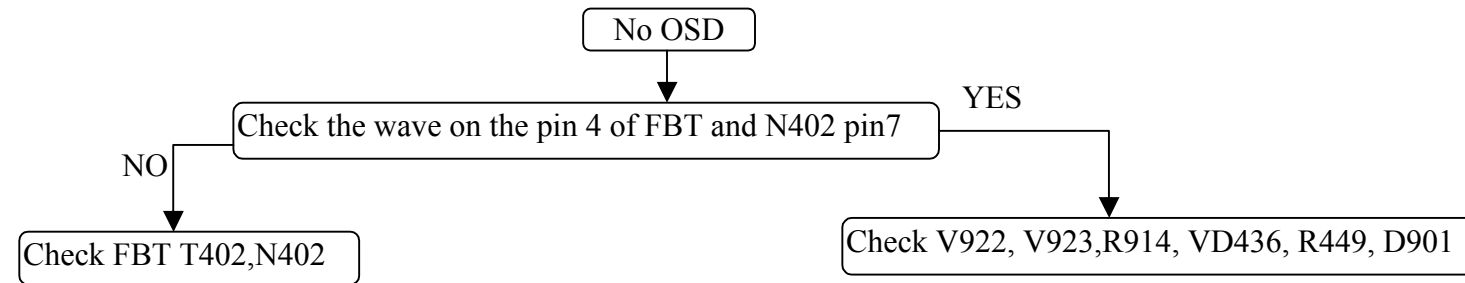

VARIOUS PARAMETERS OF INTEGRATED CIRCUIT

A: Pin functions of N201(TB1238AN)

Pin	Symbol	Function	Dynamic state (v)
1	DE-EMP	Audio deemphasis capacitor connect pin	4.9
2	AUDIO OUT	Audio signal output	3.4
3	IF VCC	+9V supply input for IF amplify circuit	9
4	AFT OUT	AFT voltage output	1.7
5	IF GND	Ground for IF amplifiter circuit	0
6	IF IN	IF signal input	0
7	IF IN	IF signal input	1.4
8	RF AGC	RF amplifier AGC control voltage output	5.6
9	IF AGC	IF amplifier AGC filter	4.4
10	APC FILTER	APC filtering	1.8
11	4.43MHZXTA	4.43MHZ crystal oscillating	2.2
12	Y/C GND	Ground (Y/C signal processor)	0
13	YS/YM	Y-switch signal input	0
14	EXT R IN	Character R signal input	0.9
15	EXT G IN	Character G signal input	0.9
16	EXT B IN	Character B signal input	0.9
17	RGB VCC	Supply input(RGB)	9
18	R OUT	R output	2.4
19	G OUT	G output	2.4
20	B OUT	B output	2.5
21	ABCL	Automatic brightness, contrast control	5.4
22	V RAMP	Vertical Ramp generator capacitor connect pin	4.4
23	V NFB	V NFB input	5
24	V OUT	Vertical pulse signal output	1
25	V AGC	V AGC filter capacitor connect pin	0.3
26	SCL	(IIC)clock line	3.8
27	SDA	(IIC)data line	3.9
28	H VCC	Horizontal deflection supply input (+9V)	9.6
29	SID/CW OUT	SECAM identification/CW signal output	3.8
30	FBP IN	Horizontal flyback pulse input	4.8
31	SYNC OUT	SYNC pulse output	4.8
32	H OUT	Horizontal excitation output	2
33	DEF GND	Ground (detection circuit)	0
34	FBP IN	Sandcastle pulse output	1.4
35	VIDEO OUT	Video signal output	3
36	DIG. VD	Digital circuit supply	5.3
37	S R-Y IN	SECAM R-Y signal input	2.7
38	S B-Y IN	SECAM B-Y signal input	2.6
39	Y IN	Luminance signal input	1.1
40	H AFC	Connecting RC network for horizontal AFC filter	6.8
41	EXT.VIDEO/Y IN	External video/luminance signal input	1.6
42	DIG.GND	Digital circuit ground	0
43	TV.VIDEO IN	TV. video signal input	3.2

44	BLACK DEF	Black level detecting filter	2.4
45	EXT.CIN	External chroma signal input	2.9
46	Y/C VCC	+5V supply input (Y/C processing system)	5.2
47	IF DETOUT	IF video detected output	3.7
48	LOOP Filter	Connecting RC filter network for phase loop circuit	4.8
49	VCO GND	Ground (IF VCO circuit)	0
50	VCO	Voltage control oscillating coil connecting pin	8
51	VCO	Voltage control oscillating coil connecting pin	8
52	VCO VCC	+9V supply input (IF VCO circuit)	9
53	Limiter IN	Sound IF signal input	3.8
54	RIPPLE FILTER	Ripple filter circuit	4.8
55	EXT AUDIO	External audio signal input	3.4
56	FM DEC NF	FM direct current negative feedback filter capacitor can	3.8

B: Pin functions of N161 (AN7522N)

Pin.	Pin name	Signal name	Function
1	VSS	VSS	GND connection
2	P40	VT	VT output
3	P41	EXT-MUTE	External Mute Output
4	P42	MUTE	Mute Output
5	P43	VOLUME-L	Left Volume PWM control
6	P44	VOLUME-R	Right Volume PWM control
7	P45	POWER	Power control &Check,On=Hi-Z(input),Off=L(output)
8	P46	Tone	Tone control
9	P47	BAND1	BAND data output1
10	P50	BAND2	BAND data output2
11	P51	SCL1	IIC-BUS SCL1
12	P52	SDA1	IIC-BUS SDA1
13	P53	AFC	AFC input
14	P54	AV2	Video mode selection control No.2
15	P55	KEY-IN1	Key input1
16	P56	KEY-IN2	Key input2
17	P60	AC POWER	AC POWER ON/OFF
18	P61	SIF3	SIF Output3
19	P62	RF GAIN	RF GAIN ON/OFF
20	P63	50/60	50/60Hz Output
21	VSS	VSS	GND connection
22	P64	R	OSD R signal output
23	P65	G	OSD G signal output
24	P66	B	OSD B signal output
25	P67	Y	OSD Y signal output
26	P70	HD	OSD HD signal output
27	P71	VD	OSD VD signal output
28	P72	OSC1	OSD oscillator connection
29	P73	OSC2	OSD oscillator connection
30	TEST	TEST	GND connection
31	XIN	XIN	8 MHz oscillator connection
32	XOUT	XOUT	8 MHz oscillator connection
33	RESET	RESET	Reset signal input
34	P20	AV1	Video mode selection control No.1
35	P30	REMOTE	Remote controller signal input
36	P31	H.SYNC	Horizontal sync signal input
37	P34	SCL0	IIC-BUS SCL0
38	P35	SDA0	IIC-BUS SDA0
39	P57	S-ID	S-VIDEO Detection
40	P32	SIF1	SIF data output1
41	P33	SIF2	SIF data output2
42	VDD	VDD	5V power supply

C: Pin functions of N402 (LA78040)

Pin	Symbol	Function
1	Vcc1	Power supply 1
2	IN	Sound input
3	LF	Low frequency input
4	VOL-CTL	Volume control
5	TONE-CTL	Tone control
6	RF	Ripple filter
7	GND	Ground
8	OUT	Sound output
9	Vcc2	Power supply 2

C: Pin functions of N101 (LA7910)

Pin	Symbol	Function
1	OUT1	Decoder output 1
2	OUT2	Decoder output 2
3	BD1	Band control level input 1
4	BD2	Band control level input 2
5	GND	Connect to ground
6	VC2	+33V supply input pin
7	OUT3	Decoder output 3
8	OUT4	Decoder output 4
9	VC1	+12V supply input pin

D: Pin functions of N101 (LA7830)

Pin	Symbol	Function
1	GND	Connect to ground
2	OUT	Field pulse output
3		Pump power supply input
4	IN	V sawtooth pulse input
5		Connet to phase compensate capacitance
6	Vcc	Power supply pin
7		Pump power supply output

D: Pin functions of N251 (TA1275)

Pin	Symbol	Function
1	YOUT	The output pin for Y signal standard output level is 1.0Vp-p.
2	MODESW	The pin for controlling the Y processing mode.
3	R-Y OUT	The output pin for demodulated R-Y signal
4	R-Y BLACK CONTROL	The pin for controlling the black offset level.
5	B-Y OUT	The output pin for demodulated B-Y signal.
6	B-Y BLACK CONTROL	The pin for controlling the black offset level.
7	S-ID FILTER	The pin for connecting the SECAM identification filter capacitor.
8	EXT. R-Y IN	The input pin for external R-Y signal.
9	5V Vcc	The Vcc pin for Y/C processing block.
10	EXT.B-Y IN	The input pin for external B-Y signal.
11	GND	The GND pin
12	FO-ADJ. FILTER	The pin for connecting a capacitor for automatic adjusting circuit
13	C IN	The chroma signal input pin.
14	BELLADJ. FILTER	The pin for connection the filter capacitor for the bell filter FO.
15	Y IN	The Y signal input pin.
16	GND	
17	SCP IN	The pin for input the sandcastle pulse
18	5V Vc-c	Vc-c pin for logic block
19	4.43MHz CW IN	The pin for input 4.43MHz of carrier wave for self-adjustment circuit.
20	ID SW	The switch pin for selecting the ID detection mode.
21	SECAM ID IN/OUT	The interface pin to the main processor TB1238AN

The BUS DATA for 87CM38N-3GN5

Number	Adjustment Item	Adjustment Function	Type Data
1.	RCUT	Red Dard Balance	5E
2.	GCUT	Green Dark Balance	72
3.	BCUT	Blue Dark Balance	7D
4.	GDRV	Green light Balance	3B
5.	BDRV	Blue light Balance	3E
6.	CNTX	Sub Contrast Max	3F
7.	BRTC	Sub-bright Centre	48
8.	COLC	Sub Color Center(NTSC)	40
9.	TNTC	Sub Tint Center	40
10.	COLP	Sub Color Center(PAL Difference)	20
11.	COLS	Sub Color Center(SECAM)	40
12.	SCNT	Sub Contrast	0B
13.	CNTC	Sub Contrast Center	30
14.	CNTN	Sub Contrast min	00
15.	BRTX	Sub-bright max(difference)	30
16.	BRTN	Sub-bright min(difference)	30
17.	COLX	Sub color max(difference)	35
18.	COLN	Sub color min	00
19.	TNTX	Sub tint max(difference)	28
20.	TNTN	Sub tint min(difference)	28
21.	ST3	Sub sharp center(3.58NTSC TV)	25
22.	SV3	Sub sharp center(3.58NTSC AV)	25
23.	ST4	Sub sharp center(OTHER TV)	25
24.	SV4	Sub sharp center(OTHER AV)	25
25.	SHPX	Sub sharpness max(difference)	35
26.	SHPN	Sub sharpness min(difference)	35
27.	TXCX	Text RGB contrast max	35
28.	RGCN	Text RGB contrast min	25
29.	VM0	V/C/D mode data 0	0E
30.	VM1	V/C/D mode data 1	00
31.	HPOS	Horizontal center of 50 Hz	0A
32.	VP50	Vertical centering of 50 Hz	06
33.	HIT	Vertical amplitude of 50 Hz	2C
34.	HPS	Horizontal centering difference of 60 Hz	03
35.	VP60	Vertical centering difference of 60 Hz	02
36.	HITS	Vertical amplitude deflection of 60Hz	02
37.	VLIN	Vertical line of 50 Hz	0B
38.	VSC	Vertical S correction/50 Hz	07
39.	VLIS	Vertical line deflection of 60 Hz	00
40.	HIT0	50Hz SIZE ZOOM/WIDE V.	19
41.	HIT1	60Hz SIZE ZOOM/WIDE V.	00
42.	SBY	SECAM B-Y Black	08
43.	SRY	SECAM R-Y Black	08
44.	RAGC	RF AGC	25
45.	AFT	PIF VCO center	40
46.	HAFC	AFC gain	00
47.	V25	Volume 25%	37

48.	V50	Volume 50%	5D
49.	BRTS	Sub bright (difference)	00
50.	VM2	TB1238AN V/C/D mode data	34
51.	MOD0	Factory data	43
52.	MOD1	Factory data	F5
53.	MOD2	Factory data	0F
54.	SELF	TB1238AN P40UT select	00
55.	SELF VOC	Self adjust VCD initial data	80
56.	SELF AGC	Self adjust AGC initial data	69
57.	SELF BRTC	Self adjust BRTC initial data	75
58.	SELF CNTC	Self adjust CNTC initial data	23
59.	SELF TNTC	Self adjust TNTC initial data	00
60.	SELF COL	Self adjust COL initial data	20
61.	OSD	OSD position	07
62.	OPT	Factory Data	07

The BUS DATA for 87CK38N-2B46

Number	Adjustment Item	Adjustment Function	Type Data
1.	RCUT	Red Dard Balance	5E
2.	GCUT	Green Dark Balance	72
3.	BCUT	Blue Dark Balance	7D
4.	GDRV	Green light Balance	3B
5.	BDRV	Blue light Balance	3E
6.	CNTX	Sub Contrast Max	3F
7.	BRTC	Sub-bright Centre	48
8.	COLC	Sub Color Center(NTSC)	40
9.	TNTC	Sub Tint Center	40
10.	COLP	Sub Color Center(PAL Difference)	20
11.	COLS	Sub Color Center(SECAM)	40
12.	SCNT	Sub Contrast	0B
13.	CNTC	Sub Contrast Center	30
14.	CNTN	Sub Contrast min	00
15.	BRTX	Sub-bright max(difference)	30
16.	BRTN	Sub-bright min(difference)	30
17.	COLX	Sub color max(difference)	35
18.	COLN	Sub color min	00
19.	TNTX	Sub tint max(difference)	28
20.	TNTN	Sub tint min(difference)	28
21.	ST3	Sub sharp center(3.58NTSC TV)	25
22.	SV3	Sub sharp center(3.58NTSC AV)	25
23.	ST4	Sub sharp center(OTHER TV)	25
24.	SV4	Sub sharp center(OTHER AV)	25
25.	SHPX	Sub sharpness max(difference)	35
26.	SHPN	Sub sharpness min(difference)	35
27.	TXCX	Text RGB contrast max	35
28.	RGCN	Text RGB contrast min	25

29.	VM0	V/C/D mode data 0	0E
30.	VM1	V/C/D mode data 1	00
31.	HPOS	Horizontal center of 50 Hz	0A
32.	VP50	Vertical centering of 50 Hz	06
33.	HIT	Vertical amplitude of 50 Hz	2C
34.	HPS	Horizontal centering difference of 60 Hz	03
35.	VP60	Vertical centering difference of 60 Hz	02
36.	HITS	Vertical amplitude deflection of 60Hz	02
37.	VLIN	Vertical line of 50 Hz	0B
38.	VSC	Vertical S correction/50 Hz	07
39.	VLIS	Vertical line deflection of 60 Hz	00
40.	HIT0	50Hz SIZE ZOOM/WIDE V.	19
41.	HIT1	60Hz SIZE ZOOM/WIDE V.	00
42.	SBY	SECAM B-Y Black	08
43.	SRY	SECAM R-Y Black	08
44.	RAGC	RF AGC	25
45.	AFT	PIF VCO center	40
46.	HAFC	AFC gain	00
47.	V25	Volume 25%	37
48.	V50	Volume 50%	5D
49.	BRTS	Sub bright (difference)	00
50.	VM2	TB1238AN V/C/D mode data	34
51.	MOD0	Factory data	43
52.	MOD1	Factory data	70
53.	MOD2	Factory data	05
54.	SELF	TB1238AN P40UT select	00
55.	SELF VOC	Self adjust VCD initial data	80
56.	SELF AGC	Self adjust AGC initial data	69
57.	SELF BRTC	Self adjust BRTC initial data	75
58.	SELF CNTC	Self adjust CNTC initial data	23
59.	SELF TNTC	Self adjust TNTC initial data	00
60.	SELF COL	Self adjust COL initial data	20
61.	OSD	OSD position	07
62.	OPT	Factory Data	07

NOTE:

The data provided in the form provides to consult only!

ELECTRICAL PARTS LIST

PRODUCT SAFETY NOTE: products marked with a ! have special characteristics important to safety. Before replacing any of these components, read carefully the product safety notice in this service manual. Don't degrade the safety of the product through improper servicing.

NOTE: parts that not assigned part numbers() are not available.

Tolerance of Capacitors and Resistors are noted with the following symbols.

C.....±0.25% D.....±0.5% F.....±1% G..... ±2%
 J..... ±5% K..... ±10% M..... ±20% N..... ±30%
 Z.....+80/-20%

Ref. No	Part No.	Name	Specification
R444	D10B4R7J-T	Carbon resistor	RT13-1/6W-4.7Ω±5%
R632	D10B4R7J-T	Carbon resistor	RT13-1/6W-4.7Ω±5%
R701	D10B4R7J-T	Carbon resistor	RT13-1/6W-4.7Ω±5%
R711	D10B4R7J-T	Carbon resistor	RT13-1/6W-4.7Ω±5%
R279	D10B330J-T	Carbon resistor	RT13-1/6W-33Ω±5%
R602	D10B330J-T	Carbon resistor	RT13-1/6W-33Ω±5%
R612	D10B330J-T	Carbon resistor	RT13-1/6W-33Ω±5%
R622	D10B330J-T	Carbon resistor	RT13-1/6W-33Ω±5%
R248	D10B680J-T	Carbon resistor	RT13-1/6W-68Ω±5%
R219	D10B750J-T	Carbon resistor	RT13-1/6W-75Ω±5%
R221	D10B750J-T	Carbon resistor	RT13-1/6W-75Ω±5%
R266	D10B750J-T	Carbon resistor	RT13-1/6W-75Ω±5%
R111	D10B101J-T	Carbon resistor	RT13-1/6W-100Ω±5%
R201	D10B101J-T	Carbon resistor	RT13-1/6W-100Ω±5%
R207	D10B101J-T	Carbon resistor	RT13-1/6W-100Ω±5%
R210	D10B101J-T	Carbon resistor	RT13-1/6W-100Ω±5%
R216	D10B101J-T	Carbon resistor	RT13-1/6W-100Ω±5%
R218	D10B101J-T	Carbon resistor	RT13-1/6W-100Ω±5%
R220	D10B101J-T	Carbon resistor	RT13-1/6W-100Ω±5%
R222	D10B101J-T	Carbon resistor	RT13-1/6W-100Ω±5%
R225	D10B101J-T	Carbon resistor	RT13-1/6W-100Ω±5%
R226	D10B101J-T	Carbon resistor	RT13-1/6W-100Ω±5%
R232	D10B101J-T	Carbon resistor	RT13-1/6W-100Ω±5%
R238	D10B101J-T	Carbon resistor	RT13-1/6W-100Ω±5%
R264	D10B101J-T	Carbon resistor	RT13-1/6W-100Ω±5%
R265	D10B101J-T	Carbon resistor	RT13-1/6W-100Ω±5%
R971	D10B101J-T	Carbon resistor	RT13-1/6W-100Ω±5%
R972	D10B101J-T	Carbon resistor	RT13-1/6W-100Ω±5%
R236	D10B151J-T	Carbon resistor	RT13-1/6W-150Ω±5%
R404	D10B151J-T	Carbon resistor	RT13-1/6W-150Ω±5%
R604	D10B151J-T	Carbon resistor	RT13-1/6W-150Ω±5%
R614	D10B151J-T	Carbon resistor	RT13-1/6W-150Ω±5%
R624	D10B151J-T	Carbon resistor	RT13-1/6W-150Ω±5%
R106	D10B221J-T	Carbon resistor	RT13-1/6W-220Ω±5%
R107	D10B221J-T	Carbon resistor	RT13-1/6W-220Ω±5%
R217	D10B221J-T	Carbon resistor	RT13-1/6W-220Ω±5%
R234	D10B221J-T	Carbon resistor	RT13-1/6W-220Ω±5%
R241	D10B221J-T	Carbon resistor	RT13-1/6W-220Ω±5%
R244	D10B221J-T	Carbon resistor	RT13-1/6W-220Ω±5%
R247	D10B221J-T	Carbon resistor	RT13-1/6W-220Ω±5%

R607	D10B221J-T	Carbon resistor	RT13-1/6W-220Ω±5%
R617	D10B221J-T	Carbon resistor	RT13-1/6W-220Ω±5%
R627	D10B221J-T	Carbon resistor	RT13-1/6W-220Ω±5%
R633	D10B221J-T	Carbon resistor	RT13-1/6W-220Ω±5%
R271	D10B271J-T	Carbon resistor	RT13-1/6W-270Ω±5%
R272	D10B271J-T	Carbon resistor	RT13-1/6W-270Ω±5%
R273	D10B271J-T	Carbon resistor	RT13-1/6W-270Ω±5%
R203	D10B471J-T	Carbon resistor	RT13-1/6W-470Ω±5%
R215	D10B471J-T	Carbon resistor	RT13-1/6W-470Ω±5%
R205	D10B561J-T	Carbon resistor	RT13-1/6W-560Ω±5%
R249	D10B561J-T	Carbon resistor	RT13-1/6W-560Ω±5%
R250	D10B561J-T	Carbon resistor	RT13-1/6W-560Ω±5%
R634	D10B561J-T	Carbon resistor	RT13-1/6W-560Ω±5%
R937	D10B561J-T	Carbon resistor	RT13-1/6W-560Ω±5%
R114	D10B102J-T	Carbon resistor	RT13-1/6W-1KΩ±5%
R115	D10B102J-T	Carbon resistor	RT13-1/6W-1KΩ±5%
R202	D10B102J-T	Carbon resistor	RT13-1/6W-1KΩ±5%
R233	D10B102J-T	Carbon resistor	RT13-1/6W-1KΩ±5%
R246	D10B102J-T	Carbon resistor	RT13-1/6W-1KΩ±5%
R251	D10B102J-T	Carbon resistor	RT13-1/6W-1KΩ±5%
R252	D10B102J-T	Carbon resistor	RT13-1/6W-1KΩ±5%
R267	D10B102J-T	Carbon resistor	RT13-1/6W-1KΩ±5%
R268	D10B102J-T	Carbon resistor	RT13-1/6W-1KΩ±5%
R269	D10B102J-T	Carbon resistor	RT13-1/6W-1KΩ±5%
R423	D10B102J-T	Carbon resistor	RT13-1/6W-1KΩ±5%
R517	D10B102J-T	Carbon resistor	RT13-1/6W-1KΩ±5%
R603	D10B102J-T	Carbon resistor	RT13-1/6W-1KΩ±5%
R613	D10B102J-T	Carbon resistor	RT13-1/6W-1KΩ±5%
R623	D10B102J-T	Carbon resistor	RT13-1/6W-1KΩ±5%
R635	D10B102J-T	Carbon resistor	RT13-1/6W-1KΩ±5%
R703	D10B102J-T	Carbon resistor	RT13-1/6W-1KΩ±5%
R705	D10B102J-T	Carbon resistor	RT13-1/6W-1KΩ±5%
R713	D10B102J-T	Carbon resistor	RT13-1/6W-1KΩ±5%
R719	D10B102J-T	Carbon resistor	RT13-1/6W-1KΩ±5%
R720	D10B102J-T	Carbon resistor	RT13-1/6W-1KΩ±5%
R907	D10B102J-T	Carbon resistor	RT13-1/6W-1KΩ±5%
R908	D10B102J-T	Carbon resistor	RT13-1/6W-1KΩ±5%
R934	D10B102J-T	Carbon resistor	RT13-1/6W-1KΩ±5%
R945	D10B102J-T	Carbon resistor	RT13-1/6W-1KΩ±5%
R948	D10B102J-T	Carbon resistor	RT13-1/6W-1KΩ±5%
R957	D10B102J-T	Carbon resistor	RT13-1/6W-1KΩ±5%
R958	D10B102J-T	Carbon resistor	RT13-1/6W-1KΩ±5%
R962	D10B102J-T	Carbon resistor	RT13-1/6W-1KΩ±5%
R973	D10B102J-T	Carbon resistor	RT13-1/6W-1KΩ±5%
R980	D10B102J-T	Carbon resistor	RT13-1/6W-1KΩ±5%
R985	D10B102J-T	Carbon resistor	RT13-1/6W-1KΩ±5%
R986	D10B102J-T	Carbon resistor	RT13-1/6W-1KΩ±5%
R987	D10B102J-T	Carbon resistor	RT13-1/6W-1KΩ±5%
R988	D10B102J-T	Carbon resistor	RT13-1/6W-1KΩ±5%
R640	D10B122J-T	Carbon resistor	RT13-1/6W-1.2KΩ±5%
R211	D10B152J-T	Carbon resistor	RT13-1/6W-1.5KΩ±5%
R274	D10B152J-T	Carbon resistor	RT13-1/6W-1.5KΩ±5%
R913	D10B152J-T	Carbon resistor	RT13-1/6W-1.5KΩ±5%
R932	D10B152J-T	Carbon resistor	RT13-1/6W-1.5KΩ±5%
W913	D10B152J-T	Carbon resistor	RT13-1/6W-1.5KΩ±5%
W914	D10B152J-T	Carbon resistor	RT13-1/6W-1.5KΩ±5%
R119	D10B222J-T	Carbon resistor	RT13-1/6W-2.2KΩ±5%

R204	D10B222J-T	Carbon resistor	RT13-1/6W-2.2K Ω ±5%
R255	D10B222J-T	Carbon resistor	RT13-1/6W-2.2K Ω ±5%
R949	D10B222J-T	Carbon resistor	RT13-1/6W-2.2K Ω ±5%
R523	D10B332J-T	Carbon resistor	RT13-1/6W-3.3K Ω ±5%
R925	D10B332J-T	Carbon resistor	RT13-1/6W-3.3K Ω ±5%
R928	D10B332J-T	Carbon resistor	RT13-1/6W-3.3K Ω ±5%
R996	D10B332J-T	Carbon resistor	RT13-1/6W-3.3K Ω ±5%
R559	D10B392J-T	Carbon resistor	RT13-1/6W-3.9K Ω ±5%
R108	D10B472J-T	Carbon resistor	RT13-1/6W-4.7K Ω ±5%
R715	D10B472J-T	Carbon resistor	RT13-1/6W-4.7K Ω ±5%
R922	D10B472J-T	Carbon resistor	RT13-1/6W-4.7K Ω ±5%
R938	D10B472J-T	Carbon resistor	RT13-1/6W-4.7K Ω ±5%
R118	D10B562J-T	Carbon resistor	RT13-1/6W-5.6K Ω ±5%
R208	D10B562J-T	Carbon resistor	RT13-1/6W-5.6K Ω ±5%
R263	D10B562J-T	Carbon resistor	RT13-1/6W-5.6K Ω ±5%
R295	D10B562J-T	Carbon resistor	RT13-1/6W-5.6K Ω ±5%
R511	D10B562J-T	Carbon resistor	RT13-1/6W-5.6K Ω ±5%
R706	D10B562J-T	Carbon resistor	RT13-1/6W-5.6K Ω ±5%
R716	D10B562J-T	Carbon resistor	RT13-1/6W-5.6K Ω ±5%
R905	D10B562J-T	Carbon resistor	RT13-1/6W-5.6K Ω ±5%
R921	D10B562J-T	Carbon resistor	RT13-1/6W-5.6K Ω ±5%
R926	D10B562J-T	Carbon resistor	RT13-1/6W-5.6K Ω ±5%
R940	D10B562J-T	Carbon resistor	RT13-1/6W-5.6K Ω ±5%
R979	D10B562J-T	Carbon resistor	RT13-1/6W-5.6K Ω ±5%
R253	D10B682J-T	Carbon resistor	RT13-1/6W-6.8K Ω ±5%
R933	D10B822J-T	Carbon resistor	RT13-1/6W-8.2K Ω ±5%
R110	D10B103J-T	Carbon resistor	RT13-1/6W-10K Ω ±5%
R116	D10B103J-T	Carbon resistor	RT13-1/6W-10K Ω ±5%
R117	D10B103J-T	Carbon resistor	RT13-1/6W-10K Ω ±5%
R258	D10B103J-T	Carbon resistor	RT13-1/6W-10K Ω ±5%
R291	D10B103J-T	Carbon resistor	RT13-1/6W-10K Ω ±5%
R292	D10B103J-T	Carbon resistor	RT13-1/6W-10K Ω ±5%
R293	D10B103J-T	Carbon resistor	RT13-1/6W-10K Ω ±5%
R562	D10B103J-T	Carbon resistor	RT13-1/6W-10K Ω ±5%
R906	D10B103J-T	Carbon resistor	RT13-1/6W-10K Ω ±5%
R927	D10B103J-T	Carbon resistor	RT13-1/6W-10K Ω ±5%
R935	D10B103J-T	Carbon resistor	RT13-1/6W-10K Ω ±5%
R943	D10B103J-T	Carbon resistor	RT13-1/6W-10K Ω ±5%
R951	D10B103J-T	Carbon resistor	RT13-1/6W-10K Ω ±5%
R952	D10B103J-T	Carbon resistor	RT13-1/6W-10K Ω ±5%
R955	D10B103J-T	Carbon resistor	RT13-1/6W-10K Ω ±5%
R956	D10B103J-T	Carbon resistor	RT13-1/6W-10K Ω ±5%
R959	D10B103J-T	Carbon resistor	RT13-1/6W-10K Ω ±5%
R968	D10B103J-T	Carbon resistor	RT13-1/6W-10K Ω ±5%
R969	D10B103J-T	Carbon resistor	RT13-1/6W-10K Ω ±5%
R976	D10B103J-T	Carbon resistor	RT13-1/6W-10K Ω ±5%
R977	D10B103J-T	Carbon resistor	RT13-1/6W-10K Ω ±5%
R983	D10B103J-T	Carbon resistor	RT13-1/6W-10K Ω ±5%
R984	D10B103J-T	Carbon resistor	RT13-1/6W-10K Ω ±5%
R991	D10B103J-T	Carbon resistor	RT13-1/6W-10K Ω ±5%
R992	D10B103J-T	Carbon resistor	RT13-1/6W-10K Ω ±5%
R920	D10B123J-T	Carbon resistor	RT13-1/6W-12K Ω ±5%
R993	D10B123J-T	Carbon resistor	RT13-1/6W-12K Ω ±5%
R994	D10B123J-T	Carbon resistor	RT13-1/6W-12K Ω ±5%
R102	D10B153J-T	Carbon resistor	RT13-1/6W-15K Ω ±5%
R294	D10B153J-T	Carbon resistor	RT13-1/6W-15K Ω ±5%
R929	D10B153J-T	Carbon resistor	RT13-1/6W-15K Ω ±5%

R900	D10B183J-T	Carbon resistor	RT13-1/6W-18K Ω \pm 5%
R970	D10B183J-T	Carbon resistor	RT13-1/6W-18K Ω \pm 5%
R978	D10B183J-T	Carbon resistor	RT13-1/6W-18K Ω \pm 5%
R1007	D10B223J-T	Carbon resistor	RT13-1/6W-22K Ω \pm 5%
R1010	D10B223J-T	Carbon resistor	RT13-1/6W-22K Ω \pm 5%
R515	D10B223J-T	Carbon resistor	RT13-1/6W-22K Ω \pm 5%
R551	D10B223J-T	Carbon resistor	RT13-1/6W-22K Ω \pm 5%
R571	D10B223J-T	Carbon resistor	RT13-1/6W-22K Ω \pm 5%
R572	D10B223J-T	Carbon resistor	RT13-1/6W-22K Ω \pm 5%
R904	D10B223J-T	Carbon resistor	RT13-1/6W-22K Ω \pm 5%
R990	D10B223J-T	Carbon resistor	RT13-1/6W-22K Ω \pm 5%
R278	D10B333J-T	Carbon resistor	RT13-1/6W-33K Ω \pm 5%
R447	D10B333J-T	Carbon resistor	RT13-1/6W-33K Ω \pm 5%
R914	D10B333J-T	Carbon resistor	RT13-1/6W-33K Ω \pm 5%
R960	D10B333J-T	Carbon resistor	RT13-1/6W-33K Ω \pm 5%
R965	D10B333J-T	Carbon resistor	RT13-1/6W-33K Ω \pm 5%
R974	D10B333J-T	Carbon resistor	RT13-1/6W-33K Ω \pm 5%
R975	D10B333J-T	Carbon resistor	RT13-1/6W-33K Ω \pm 5%
R113	D10B473J-T	Carbon resistor	RT13-1/6W-47K Ω \pm 5%
R206	D10B473J-T	Carbon resistor	RT13-1/6W-47K Ω \pm 5%
R256	D10B473J-T	Carbon resistor	RT13-1/6W-47K Ω \pm 5%
R448	D10B473J-T	Carbon resistor	RT13-1/6W-47K Ω \pm 5%
R446	D10B563J-T	Carbon resistor	RT13-1/6W-56K Ω \pm 5%
R923	D10B563J-T	Carbon resistor	RT13-1/6W-56K Ω \pm 5%
R1006	D10B683J-T	Carbon resistor	RT13-1/6W-68K Ω \pm 5%
R1009	D10B683J-T	Carbon resistor	RT13-1/6W-68K Ω \pm 5%
R200	D10B104J-T	Carbon resistor	RT13-1/6W-100K Ω \pm 5%
R254	D10B104J-T	Carbon resistor	RT13-1/6W-100K Ω \pm 5%
R259	D10B104J-T	Carbon resistor	RT13-1/6W-100K Ω \pm 5%
R989	D10B104J-T	Carbon resistor	RT13-1/6W-100K Ω \pm 5%
R443	D10B124J-T	Carbon resistor	RT13-1/6W-120K Ω \pm 5%
R101	D10B224J-T	Carbon resistor	RT13-1/6W-220K Ω \pm 5%
R262	D10B224J-T	Carbon resistor	RT13-1/6W-220K Ω \pm 5%
R455	D10B224J-T	Carbon resistor	RT13-1/6W-220K Ω \pm 5%
R237	D10B824J-T	Carbon resistor	RT13-1/6W-820K Ω \pm 5%
R257	D10B225J-T	Carbon resistor	RT13-1/6W-2.2M Ω \pm 5%
R519	D10C220J-T	Carbon resistor	RT14-1/4W-22 Ω \pm 5%
R261	D10C221J-T	Carbon resistor	RT14-1/4W-220 Ω \pm 5%
R901	D10C471J-T	Carbon resistor	RT14-1/4W-470 Ω \pm 5%
R944	D10C681J-T	Carbon resistor	RT14-1/4W-680 Ω \pm 5%
R912	D10C102J-T	Carbon resistor	RT14-1/4W-1K Ω \pm 5%
R526	D10C272J-T	Carbon resistor	RT14-1/4W-2.7K Ω \pm 5%
R557	D10C472J-T	Carbon resistor	RT14-1/4W-4.7K Ω \pm 5%
R424	D10C153J-T	Carbon resistor	RT14-1/4W-15K Ω \pm 5%
R449	D10C153J-T	Carbon resistor	RT14-1/4W-15K Ω \pm 5%
R522	D10C153J-T	Carbon resistor	RT14-1/4W-15K Ω \pm 5%
R555	D10C473J-T	Carbon resistor	RT14-1/4W-47K Ω \pm 5%
R556	D10C473J-T	Carbon resistor	RT14-1/4W-47K Ω \pm 5%
R566	D10C104J-T	Carbon resistor	RT14-1/4W-100K Ω \pm 5%
R554	D10C154J-T	Carbon resistor	RT14-1/4W-150K Ω \pm 5%
R445	D10D1R8J-T	Carbon resistor	RT15-1/2W-1.8 Ω \pm 5%
R442	D10D331J-T	Carbon resistor	RT15-1/2W-330 Ω \pm 5%
R407	D10D102J-T	Carbon resistor	RT15-1/2W-1K Ω \pm 5%
R560	D10D332J-T	Carbon resistor	RT15-1/2W-3.3K Ω \pm 5%
R605	D10D332J-T	Carbon resistor	RT15-1/2W-3.3K Ω \pm 5%
R615	D10D332J-T	Carbon resistor	RT15-1/2W-3.3K Ω \pm 5%
R625	D10D332J-T	Carbon resistor	RT15-1/2W-3.3K Ω \pm 5%

R462	D10D682J-T	Carbon resistor	RT15-1/2W-6.8KΩ±5%
R552	D10D473J-T	Carbon resistor	RT15-1/2W-47KΩ±5%
R520	D10D104J-T	Carbon resistor	RT15-1/2W-100KΩ±5%
R521	D10D104J-T	Carbon resistor	RT15-1/2W-100KΩ±5%
R501	D10D224J-T	Carbon resistor	RT15-1/2W-220KΩ±5%
R561	D10D224J-T	Carbon resistor	RT15-1/2W-220KΩ±5%
R413	S10E102J-S(A)	Metal oxide resistor	RY16/RY21-1W-1KΩ±5%
R630	S10F3R3J-C	Metal oxide resistor	RY17/RY21-2W-3.3Ω±5%
R564	S10E471J-C	Metal oxide resistor	RY16/RY21-1W-470Ω±5%
R606	S10F123J-C	Metal oxide resistor	RY16/RY21-2W-12KΩ±5%
R616	S10F123J-C	Metal oxide resistor	RY16/RY21-2W-12KΩ±5%
R626	S10F123J-C	Metal oxide resistor	RY16/RY21-2W-12KΩ±5%
R525	S10F680J-C	Metal oxide resistor	RY17/RY21-2W-68Ω±5%
R936	S10F680J-C	Metal oxide resistor	RY17/RY21-2W-68Ω±5%
R939	S10F121J-C	Metal oxide resistor	RY17/RY21-2W-120Ω±5%
R437	S10F271J-C	Metal oxide resistor	RY17/RY21-2W-270Ω±5%
R553	S10F123J-C	Metal oxide resistor	RY17/RY21-2W-12KΩ±5%
R563	S10F123J-C	Metal oxide resistor	RY17/RY21-2W-12KΩ±5%
R524	S10G390J-C	Metal oxide resistor	RY18/RY21-3W-39Ω±5%
R531 !		Glass-Glazed Fixed RES	RI40-1/2W-24MΩ±5%
R558 !	F10DR47J-C	Fuse resistor	RF10-1/2W-0.47Ω±5%
R550 !	F10D1R0J-C	Fuse resistor	RF10-1/2W-1Ω±5%
R910!	F10D1R0J-C	Fuse resistor	RF10-1/2W-1Ω±5%
W560	W11H3R9K	Wire-wound resistor	RXG6-5W-3.9Ω-J
R502 !	W10J3R9K	Wire-wound resistor	RXG6-6W-3.9Ω-J
PS551	P10X180J-C	Thermistor	PTC-180HM
RP501	V11D202B	Potentiometer	WI06-2AA2KΩ
C270	C2CF150J-T	Ceramic capacitor	CC1-06A-CH-50/63V-15pF-J
C925	C2CF150J-T	Ceramic capacitor	CC1-06A-CH-50/63V-15pF-J
C926	C2CF150J-T	Ceramic capacitor	CC1-06A-CH-50/63V-15pF-J
C115	C2CF180J-T	Ceramic capacitor	CC1-06A-CH-50/63V-18pF-J
C283	C2CF470J-T	Ceramic capacitor	CC1-06A-CH-50/63V-47pF-J
C116	C2CF680J-T	Ceramic capacitor	CC1-06A-CH-50/63V-68pF-J
C214	C2BF101K-T	Ceramic capacitor	CC1-06A-RH-50/63V-100pF-J
C232	C2BF101K-T	Ceramic capacitor	CC1-06A-RH-50/63V-100pF-J
C233	C2BF101K-T	Ceramic capacitor	CC1-06A-RH-50/63V-100pF-J
C234	C2BF101K-T	Ceramic capacitor	CC1-06A-RH-50/63V-100pF-J
C236	C2BF101K-T	Ceramic capacitor	CC1-06A-RH-50/63V-100pF-J
C257	C2BF101K-T	Ceramic capacitor	CC1-06A-RH-50/63V-100pF-J
C290	C2BF101K-T	Ceramic capacitor	CC1-06A-RH-50/63V-100pF-J
C213	C2BF221K-T	Ceramic capacitor	CC1-06A-RH-50/63V-220pF-J
C602	C2BF221K-T	Ceramic capacitor	CC1-06A-RH-50/63V-220pF-J
C612	C2BF221K-T	Ceramic capacitor	CC1-06A-RH-50/63V-220pF-J
C622	C2BF221K-T	Ceramic capacitor	CC1-06A-RH-50/63V-220pF-J
C927	C2BF221K-T	Ceramic capacitor	CC1-06A-RH-50/63V-220pF-J
C928	C2BF221K-T	Ceramic capacitor	CC1-06A-RH-50/63V-220pF-J
C971	C2BF221K-T	Ceramic capacitor	CC1-06A-RH-50/63V-220pF-J
C972	C2BF221K-T	Ceramic capacitor	CC1-06A-RH-50/63V-220pF-J
C974	C2BF221K-T	Ceramic capacitor	CC1-06A-RH-50/63V-220pF-J
C601	C2BF561K-T	Ceramic capacitor	CC1-06A-RH-50/63V-560pF-J
C611	C2BF561K-T	Ceramic capacitor	CC1-06A-RH-50/63V-560pF-J
C621	C2BF561K-T	Ceramic capacitor	CC1-06A-RH-50/63V-560pF-J
C448	C2BF681K-T	Ceramic capacitor	CC1-06A-RH-50/63V-680pF-J
C446	C2BF102K-T	Ceramic capacitor	CT1-06A-2B4-50/63V-1000pF-K
C919	C2BF102K-T	Ceramic capacitor	CT1-06A-2B4-50/63V-1000pF-K

C934	C2BF102K-T	Ceramic capacitor	CT1-06A-2B4-50/63V-1000pF-K
C269	C2BF182K-T	Ceramic capacitor	CT1-06A-2B4-50/63V-1800pF-K
C447	C2BF182K-T	Ceramic capacitor	CT1-06A-2B4-50/63V-1800pF-K
C112	C2FF103Z-T	Ceramic capacitor	CT1-08A-2F4-50/63V-0.01uF-Z
C113	C2FF103Z-T	Ceramic capacitor	CT1-08A-2F4-50/63V-0.01uF-Z
C217	C2FF103Z-T	Ceramic capacitor	CT1-08A-2F4-50/63V-0.01uF-Z
C221	C2FF103Z-T	Ceramic capacitor	CT1-08A-2F4-50/63V-0.01uF-Z
C225	C2FF103Z-T	Ceramic capacitor	CT1-08A-2F4-50/63V-0.01uF-Z
C226	C2FF103Z-T	Ceramic capacitor	CT1-08A-2F4-50/63V-0.01uF-Z
C258	C2FF103Z-T	Ceramic capacitor	CT1-08A-2F4-50/63V-0.01uF-Z
C266	C2FF103Z-T	Ceramic capacitor	CT1-08A-2F4-50/63V-0.01uF-Z
C250	C2FF103Z-T	Ceramic capacitor	CT1-08A-2F4-50/63V-0.01uF-Z
C251	C2FF103Z-T	Ceramic capacitor	CT1-08A-2F4-50/63V-0.01uF-Z
C281	C2FF103Z-T	Ceramic capacitor	CT1-08A-2F4-50/63V-0.01uF-Z
C299	C2FF103Z-T	Ceramic capacitor	CT1-08A-2F4-50/63V-0.01uF-Z
C704	C2FF103Z-T	Ceramic capacitor	CT1-08A-2F4-50/63V-0.01uF-Z
C714	C2FF103Z-T	Ceramic capacitor	CT1-08A-2F4-50/63V-0.01uF-Z
C924	C2FF103Z-T	Ceramic capacitor	CT1-08A-2F4-50/63V-0.01uF-Z
C929	C2FF103Z-T	Ceramic capacitor	CT1-08A-2F4-50/63V-0.01uF-Z
C933	C2FF103Z-T	Ceramic capacitor	CT1-08A-2F4-50/63V-0.01uF-Z
C921	C2RF121J-T	Ceramic capacitor	CC1-06A-RH-50/63V-120pF-Z
C402	C2BP102K-T	Ceramic capacitor	CT1-08C-2B4-500V-1000pF-K
C450	C2BP102K-T	Ceramic capacitor	CT1-08C-2B4-500V-1000pF-K
C403	C2BP392K-T	Ceramic capacitor	CT1-08C-2B4-500V-3900pF-K
C452	C2BP392K-T	Ceramic capacitor	CT1-08C-2B4-500V-3900pF-K
C503	C2BW102K-O	Ceramic capacitor	CT81-08C-2R-1KV-1000pF-K
C504	C2BW102K-O	Ceramic capacitor	CT81-08C-2R-1KV-1000pF-K
C505	C2BW102K-O	Ceramic capacitor	CT81-08C-2R-1KV-1000pF-K
C506	C2BW102K-O	Ceramic capacitor	CT81-08C-2R-1KV-1000pF-K
C553	C2BW471K-O	Ceramic capacitor	CT81-08C-2R-1KV-470pF-K
C554	C2BW471K-O	Ceramic capacitor	CT81-08C-2R-1KV-470pF-K
C555	C2BW471K-O	Ceramic capacitor	CT81-08C-2R-1KV-470pF-K
C560	C2BW471K-O	Ceramic capacitor	CT81-08C-2R-1KV-470pF-K
C418	C2RX471K-O	Ceramic capacitor	CT81-08C-2R-2KV-470pF-K
C516	C2RX681K-O	Ceramic capacitor	CT81-08C-2R-2KV-680pF-K
C630	C2EX222Z-O	Ceramic capacitor	CT81-08C-2R-2KV-2200pF-K
C535 !	C2EM102M-O	Ceramic capacitor	CTJ1-AC250V-1000PF-±20%
C209	E20C100M-T	Electrolytic Capacitor	CD110-16V-10uF -M
C210	E20C100M-T	Electrolytic Capacitor	CD110-16V-10uF -M
C216	E20C100M-T	Electrolytic Capacitor	CD110-16V-10uF -M
C224	E20C100M-T	Electrolytic Capacitor	CD110-16V-10uF -M
C228	E20C100M-T	Electrolytic Capacitor	CD110-16V-10uF -M
C634	E20C100M-T	Electrolytic Capacitor	CD110-16V-10uF -M
C707	E20C100M-T	Electrolytic Capacitor	CD110-16V-10uF -M
C717	E20C100M-T	Electrolytic Capacitor	CD110-16V-10uF -M
C936	E20C100M-T	Electrolytic Capacitor	CD110-16V-10uF -M
C108	E20C220M-T	Electrolytic Capacitor	CD110-16V-22uF -M
C218	E20C220M-T	Electrolytic Capacitor	CD110-16V-22uF -M
C239	E20C220M-T	Electrolytic Capacitor	CD110-16V-22uF -M
C240	E20C220M-T	Electrolytic Capacitor	CD110-16V-22uF -M
C241	E20C220M-T	Electrolytic Capacitor	CD110-16V-22uF -M
C242	E20C220M-T	Electrolytic Capacitor	CD110-16V-22uF -M
C558	E20C220M-T	Electrolytic Capacitor	CD110-16V-22uF -M
C706	E20C220M-T	Electrolytic Capacitor	CD110-16V-22uF -M
C716	E20C220M-T	Electrolytic Capacitor	CD110-16V-22uF -M
C203	E20C470M-T	Electrolytic Capacitor	CD110-16V-47uF -M

C259	E20C470M-T	Electrolytic Capacitor	CD110-16V-47uF -M
C292	E20C470M-T	Electrolytic Capacitor	CD110-16V-47uF -M
C632	E20C470M-T	Electrolytic Capacitor	CD110-16V-47uF -M
C904	E20C470M-T	Electrolytic Capacitor	CD110-16V-47uF -M
C996	E20C470M-T	Electrolytic Capacitor	CD110-16V-47uF -M
C103	E20C101M-T	Electrolytic Capacitor	CD110-16V-100uF -M
C235	E20C101M-T	Electrolytic Capacitor	CD110-16V-100uF -M
C261	E20C101M-T	Electrolytic Capacitor	CD110-16V-100uF -M
C236	E20C101M-T	Electrolytic Capacitor	CD110-16V-100uF -M
C282	E20C101M-T	Electrolytic Capacitor	CD110-16V-100uF -M
C993	E20C101M-T	Electrolytic Capacitor	CD110-16V-100uF -M
C230	E20C101M-T	Electrolytic Capacitor	CD110-16V-470uF -M
C703	E20C101M-T	Electrolytic Capacitor	CD110-16V-470uF -M
C932	E20C101M-T	Electrolytic Capacitor	CD110-16V-470uF -M
C935	E20C101M-T	Electrolytic Capacitor	CD110-16V-470uF -M
C272	E20D1R0KT-T	Tantalum Capacitor	CA42-25V-1 uF -M
C279	E20D1R0KT-T	Tantalum Capacitor	CA42-25V-1 uF -M
C421	E20D4R7MN-T	NON-POLAR Capacitor	CD71-BP-25V-4.7uF-M
C557	E20D471M	Electrolytic Capacitor	CD110-25V-470uF -M
C702	E20D471M	Electrolytic Capacitor	CD110-25V-470uF -M
C712	E20D471M	Electrolytic Capacitor	CD110-25V-470uF -M
C433	E20D102M	Electrolytic Capacitor	CD110-25V-1000uF -M
C430	E20E470M-T	Electrolytic Capacitor	CD110-35V-47uF -M
C435	E20E470M-T	Electrolytic Capacitor	CD110-35V-47uF -M
C449	E20E101M-T	Electrolytic Capacitor	CD110-35V-100uF -M
C559	E20E331M	Electrolytic Capacitor	CD110-35V-330uF -M
C552	E20E102M	Electrolytic Capacitor	CD110-35V-1000uF -M
C565	E20E102M	Electrolytic Capacitor	CD110-35V-1000uF -M
C700	E20E102M	Electrolytic Capacitor	CD110-35V-1000uF -M
C212	E20FR22M-T	Electrolytic Capacitor	CD110-50V-0.22uF -M
C277	E20FR22M-T	Electrolytic Capacitor	CD110-50V-0.22uF -M
C117	E20FR47M-T	Electrolytic Capacitor	CD110-50V-0.47uF -M
C231	E20FR47M-T	Electrolytic Capacitor	CD110-50V-0.47uF -M
C271	E20FR47M-T	Electrolytic Capacitor	CD110-50V-0.47uF -M
C223	E20F1R0M-T	Electrolytic Capacitor	CD110-50V-1uF -M
C249	E20F1R0M-T	Electrolytic Capacitor	CD110-50V-1uF -M
C256	E20F1R0M-T	Electrolytic Capacitor	CD110-50V-1uF -M
C265	E20F1R0M-T	Electrolytic Capacitor	CD110-50V-1uF -M
C291	E20F1R0M-T	Electrolytic Capacitor	CD110-50V-1uF -M
C109	E20F2R2M-T	Electrolytic Capacitor	CD110-50V-2.2uF -M
C973	E20F2R2M-T	Electrolytic Capacitor	CD110-50V-2.2uF -M
C975	E20F2R2M-T	Electrolytic Capacitor	CD110-50V-2.2uF -M
C977	E20F2R2M-T	Electrolytic Capacitor	CD110-50V-2.2uF -M
C978	E20F2R2M-T	Electrolytic Capacitor	CD110-50V-2.2uF -M
C101	E20F4R7M-T	Electrolytic Capacitor	CD110-50V-4.7uF -M
C104	E20F4R7M-T	Electrolytic Capacitor	CD110-50V-4.7uF -M
C105	E20F4R7M-T	Electrolytic Capacitor	CD110-50V-4.7uF -M
C107	E20F4R7M-T	Electrolytic Capacitor	CD110-50V-4.7uF -M
C208	E20F4R7M-T	Electrolytic Capacitor	CD110-50V-4.7uF -M
C220	E20F4R7M-T	Electrolytic Capacitor	CD110-50V-4.7uF -M
C227	E20F4R7M-T	Electrolytic Capacitor	CD110-50V-4.7uF -M
C229	E20F4R7M-T	Electrolytic Capacitor	CD110-50V-4.7uF -M
C443	E20F4R7M-T	Electrolytic Capacitor	CD110-50V-4.7uF -M
C976	E20F4R7M-T	Electrolytic Capacitor	CD110-50V-4.7uF -M
C411	E21H1R0M-T	Electrolytic Capacitor	CD110-160V-1uF -M
C563	E20H101M	Electrolytic Capacitor	CD110-160V-100uF-M

C562	E20K221M	Electrolytic Capacitor	CD288-250V-22uF -M
C507	E20M121M	Electrolytic Capacitor	CD293-400V-120uF±10%
C278	F20F222J-T	Mylar capacitor	CL11-50V/63V-2200PF-K
C202	F20F472J-T	Mylar capacitor	CL11-50V/63V-4700PF-K
C705	F20F472J-T	Mylar capacitor	CL11-50V/63V-4700PF-K
C715	F20F472J-T	Mylar capacitor	CL11-50V/63V-4700PF-K
C515	F22F123J-T	Mylar capacitor	CL21X-50V/63V-0.012uF-K
C264	F20F223K-T	Mylar capacitor	CL11-50V/63V-0.022uF-K
C517	F20F223K-T	Mylar capacitor	CL11-50V/63V-0.022uF-K
C260	F20F333K-T	Mylar capacitor	CL11-50V/63V-0.033uF-K
C102	F20F104K-T	Mylar capacitor	CL11-50V/63V-0.1uF-K
C238	F20F104K-T	Mylar capacitor	CL11-50V/63V-0.1uF-K
C253	F20F104K-T	Mylar capacitor	CL11-50V/63V-0.1uF-K
C254	F20F104K-T	Mylar capacitor	CL11-50V/63V-0.1uF-K
C255	F20F104K-T	Mylar capacitor	CL11-50V/63V-0.1uF-K
C701	F20F104K-T	Mylar capacitor	CL11-50V/63V-0.1uF-K
C711	F20F104K-T	Mylar capacitor	CL11-50V/63V-0.1uF-K
C991	F20F104K-T	Mylar capacitor	CL11-50V/63V-0.1uF-K
C992	F20F104K-T	Mylar capacitor	CL11-50V/63V-0.1uF-K
C413	F20G104K-T	Mylar capacitor	CL11-100V-0.1uF-K
C444	F20G104K-T	Mylar capacitor	CL11-100V-0.1uF-K
C514	F20G104K-T	Mylar capacitor	CL11-100V-0.1uF-K
C412	F20J394J	Polypropylene capacitor	CBB21-200V-0.39uF±5%
C415 !	F20Z822J	Polypropylene capacitor	CBB81-1.6KV-8200PF-J
Ref. No	Part No.	Name	Specification
C501 !	F20R224M	Polypropylene capacitor	CBB62-250VAC-0.22uF
L414	LXXX0040	H-linear	LX40
T102	TLXX0004	Coil	04b
T211	TLXX0017	Coil	IF DETECTOR TANK
L232	L3X14R7K-T	Inductor	LGA0307-4.7uH-K
L233	L3X14R7K-T	Inductor	LGA0307-4.7uH-K
L231	L3X18R2K-T	Inductor	LGA0307-8.2uH-K
L251	L3X1150K-T	Inductor	LGA0307-15uH-K
L252	L3X1150K-T	Inductor	LGA0307-15uH-K
L253	L3X1150K-T	Inductor	LGA0307-15uH-K
L501 !	LMXX0002	Degaussing coil	
VD515 !	RX0001XX	Photoelectricity coupler	PC817B/C
VD1001	DL0008XX	LED	RED 5mm
VD266	DR0001XX-T	Diode	IS1555/IN4148A
VD514	DR0001XX-T	Diode	IS1555/IN4148A
VD516	DR0001XX-T	Diode	IS1555/IN4148A
VD518	DR0001XX-T	Diode	IS1555/IN4148A
VD558	DR0001XX-T	Diode	IS1555/IN4148A
VD559	DR0001XX-T	Diode	IS1555/IN4148A
VD601	DR0001XX-T	Diode	IS1555/IN4148A
VD611	DR0001XX-T	Diode	IS1555/IN4148A
VD621	DR0001XX-T	Diode	IS1555/IN4148A
VD630	DR0001XX-T	Diode	IS1555/IN4148A
VD631	DR0001XX-T	Diode	IS1555/IN4148A
VD904	DR0001XX-T	Diode	IS1555/IN4148A
VD910	DR0001XX-T	Diode	IS1555/IN4148A
VD911	DR0001XX-T	Diode	IS1555/IN4148A
VD961	DR0001XX-T	Diode	IS1555/IN4148A

VD968	DR0001XX-T	Diode	IS1555/IN4148A
VD970	DR0001XX-T	Diode	IS1555/IN4148A
VD972	DR0001XX-T	Diode	IS1555/IN4148A
VD973	DR0001XX-T	Diode	IS1555/IN4148A
VD517	DR0003XX-T	Diode	FR105
VD552	DR0003XX-T	Diode	FR105
VD553	DR0003XX-T	Diode	FR105
VD557	DR0003XX-T	Diode	FR105
VD434	DR0009XX-T	Diode	GP10D/FR104/IN4004
VD503	DR0015XX-T	Diode	TVR4N/TRM11C
VD504	DR0015XX-T	Diode	TVR4N/TRM11C
VD505	DR0015XX-T	Diode	TVR4N/TRM11C
VD506	DR0015XX-T	Diode	TVR4N/TRM11C
VD556	DR0017XX	Diode	RGP10J
VD554	DR0018XX	Diode	RGP10D
VD555	DR0031XX-T	Diode	TJ1010
VD551	DZ0001XX-T	Diode	RD6.2EB3/HZ7A1
VD703	DZ0001XX-T	Diode	RD6.2EB3/HZ7A1
Ref. No	Part No.	Name	Specification
VD713	DZ0001XX-T	Diode	RD6.2EB3/HZ7A1
VD436	DZ0002XX-T	Diode	RD5.1EB2/HZ5C1
VD261	DZ0002XX-T	Diode	RD5.1EB2/HZ5C1
VD922	DZ0002XX-T	Diode	RD5.1EB2/HZ5C1
VD921	DZ0006XX-T	Diode	RD3.6L/HZ4A2
VD901	DZ0015XX-T	Diode	RD5.6EB2/HZ6B1
VD519	DZ0010XX-T	Diode	RD8.2EB3/HZ9A2
N101	IXXX0020	IC	LA7910
N251	IXXX0024	IC	TA1275AZ
N202	IXXX0026	IC	CD4052BE
N904	IXXX0080	IC	upc574J/CW574
N201	IXXX0023	IC	TB1238AN
D901	IXXX0106	IC	87CM38N-3GN5/2B46
N203	IXXX0120	IC	CD4053BE
N701	IXXX0033	IC	AN5270 5W
N711	IXXX0033	IC	AN5270 5W
N252	IXXX0120	IC	LC4053B/CD4053B
N902	IXXX0118	IC	TA78M09 9V□□
N402	IXXX0043	IC	LA7830
D901	IXXX0079	IC	BR ST24C08-W
V213	RXA1015X-T	Audion	2SA1015Y/2SA608/2SA733Q
V231	RXA1015X-T	Audion	2SA1015Y/2SA608/2SA733Q
V251	RXA1015X-T	Audion	2SA1015Y/2SA608/2SA733Q
V511	RXA1015X-T	Audion	2SA1015Y/2SA608/2SA733Q
V631	RXA1015X-T	Audion	2SA1015Y/2SA608/2SA733Q
V925	RXA1015X-T	Audion	2SA1015Y/2SA608/2SA733Q
V994	RXA1015X-T	Audion	2SA1015Y/2SA608/2SA733Q
V921	RXB764XX-T	Audion	2SB764
V552	RXB892XX-T	Audion	2SB892/2SB985T
V101	RXC2216X-T	Audion	2SC2216
V602	RXC2482X	Audion	2SC2482
V612	RXC2482X	Audion	2SC2482
V622	RXC2482X	Audion	2SC2482
V444	RXC2383X-T	Audion	2SC2383-O
V512	RXC3807X	Audion	2SC3807/2SC5070
V513	RXC5287X	Audion	2SD1710/2SC4584/C5586
V102	RXC945XX-T	Audion	2SC945/2SC1815/2SC536E
V201	RXC945XX-T	Audion	2SC945/2SC1815/2SC536E

V211	RXC945XX-T	Audion	2SC945/2SC1815/2SC536E
V212	RXC945XX-T	Audion	2SC945/2SC1815/2SC536E
V214	RXC945XX-T	Audion	2SC945/2SC1815/2SC536E
V215	RXC945XX-T	Audion	2SC945/2SC1815/2SC536E
V503	RXC945XX-T	Audion	2SC945/2SC1815/2SC536E
V551	RXC945XX-T	Audion	2SC945/2SC1815/2SC536E
V601	RXC945XX-T	Audion	2SC945/2SC1815/2SC536E
V611	RXC945XX-T	Audion	2SC945/2SC1815/2SC536E
V621	RXC945XX-T	Audion	2SC945/2SC1815/2SC536E
V922	RXC945XX-T	Audion	2SC945/2SC1815/2SC536E
V923	RXC945XX-T	Audion	2SC945/2SC1815/2SC536E
V924	RXC945XX-T	Audion	2SC945/2SC1815/2SC536E
V975	RXC945XX-T	Audion	2SC945/2SC1815/2SC536E
V991	RXC945XX-T	Audion	2SC945/2SC1815/2SC536E
V927	RXC945XX-T	Audion	2SC945/2SC1815/2SC536E
V251	RXC945XX-T	Audion	2SC945/2SC1815/2SC536E
V411	RXD2499X	Audion	2SD2499/2SD1651
V901	RXD400XX-T	Audion	2SD400D
Z238	FC0004XX	TRAP FILTER	X4.5B
Z235	FC0006XX	TRAP FILTER	X6.5B
Z236	FC0007XX	TRAP FILTER	X6.0B
Z237	FC0008XX	TRAP FILTER	X5.5B
Z232	FC0011XX	Ceramic trap filter	L6.5M
Z234	FC0012XX	Ceramic trap filter	L6.0M
Z231	FC0013XX	Ceramic trap filter	L5.5M
Z233	FC0015XX	Ceramic trap filter	L4.5M
Z101		SAWF	IF38B1M/1333L
F501 !	FXXX0020	FUSE	2.5A 250V
A1001	RXXX0016	Remote receiver	HS0038
A101	T9XX0330	Tuner	TDV-3S7-9 470M
SW1001	KXXX0101	Touch switch	PUSH SW.(L:5mm)
SW1002	KXXX0101	Touch switch	PUSH SW.(L:5mm)
SW1003	KXXX0101	Touch switch	PUSH SW.(L:5mm)
SW1004	KXXX0101	Touch switch	PUSH SW.(L:5mm)
SW1005	KXXX0101	Touch switch	PUSH SW.(L:5mm)
SW1006	KXXX0101	Touch switch	PUSH SW.(L:5mm)
Z900	XC0004XX-A	XTLO	8.0M(20P)
Z280	XC0001XX-A	XTLO	4.43M
	FXXX0020	IRICO	54SX380Y22-DC01

CIRCUIT DIAGRAM

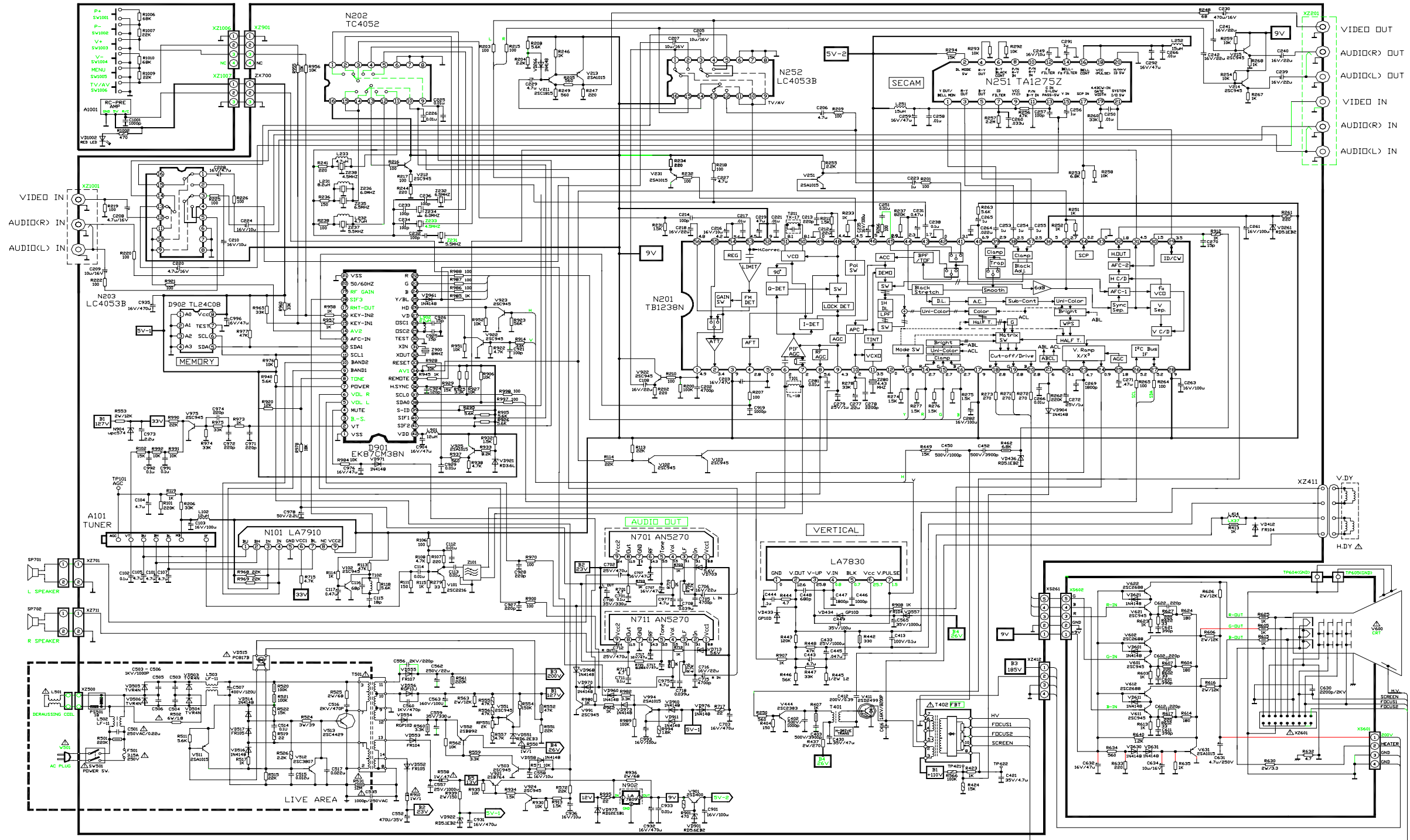

NOTICE
SINCE THIS IS A BASIC CIRCUIT DIAGRAM THE VALUE OF COMPONENTS ARE SUBJECT TO BE CHANGED FOR IMPROVEMENT.
CAUTION
THE COMPONENTS WITH '△' IN THE SCHEMATIC DIAGRAM WHICH HAVE SPECIAL CHARACTERISTICS IMPORTANT FOR SAFETY SHOULD BE REPLACED ONLY WITH TYPE IDENTICAL TO THOSE IN THE ORIGINAL CIRCUIT.